

---

***Nikon* F4S**

**Instruction Manual**

**F4**

# CONTENTS

<b>FOREWORD</b> .....	4	<b>EXPOSURE MODES</b> .....	48-59
<b>NOMENCLATURE</b> .....	5-12	Manual Exposure Mode .....	48-50
<b>OPERATION</b> .....	13-27	Programmed Auto Exposure Modes .....	51-53
MOUNTING THE LENS .....	13	Shutter-Priority Auto Exposure Mode .....	54-56
INSTALLING BATTERIES .....	14-17	Aperture-Priority Auto Exposure Mode .....	57-58
CHECKING BATTERY POWER .....	17-19	Stop-Down Exposure Metering .....	59
LOADING FILM .....	20-21	<b>EXPOSURE COMPENSATION</b> .....	60-66
FUNCTION SETTING .....	22	In Automatic Exposure Modes .....	60-62
SHOOTING .....	23-25	AE-L (Auto Exposure Lock) Button .....	60-61
REWINDING FILM .....	26-27	Exposure Compensation Dial .....	62-63
<b>CONTROLS IN DETAIL</b> .....	28-78	In Manual Exposure Mode .....	64-65
FILM SPEED DIAL .....	28-29	Auto Exposure Bracketing .....	66
Using DX-Coded Film .....	28	<b>SHUTTER SPEED DIAL</b> .....	67-68
Manual Film Speed Setting .....	29	B Setting .....	67
FILM ADVANCE MODES .....	30-31	T Setting .....	68
Mode Selection .....	31	X Setting .....	68
<b>FOCUS MODES</b> .....	32-43	<b>DEPTH-OF-FIELD PREVIEW BUTTON</b> .....	69
Manual Focus with Electronic Range Finder .....	32-33	<b>METER COUPLING LEVER</b> .....	70
Manual Focus Using Clear Matte Field .....	34	<b>MIRROR LOCKUP LEVER</b> .....	71
Autofocus .....	35	<b>SELF-TIMER</b> .....	72
Autofocus Operation .....	35-36	<b>MULTIPLE EXPOSURE LEVER</b> .....	73
Focus Tracking .....	37-38	<b>ALTERNATIVE SHUTTER RELEASE BUTTON</b> .....	74
Taking Pictures with Main Subject Off-Center .....	39-41	<b>SYNC TERMINAL</b> .....	75
Special Focusing Situations .....	41	<b>VIEWFINDER ILLUMINATOR SWITCH</b> .....	75
Autofocus with Optional Autofocus Speedlights .....	42	<b>MULTI-METER FINDER DP-20</b> .....	76-78
Freeze Focus .....	43	Diopter Adjustment Knob .....	77
<b>EXPOSURE METERING SYSTEMS</b> .....	44-47	Eyepiece Shutter Lever .....	77
Matrix Metering .....	44	Exposure Compensation Dial for Interchangeable	
Center-Weighted Metering .....	45	Focusing Screens .....	78
Spot Metering .....	45	Accessory Shoe .....	78
Metering System Selection .....	46-47		

---

<b>FLASH PHOTOGRAPHY</b> .....	79-85
Matrix Balanced Fill-Flash in Each Exposure Mode ..	80-81
Matrix Balanced Fill-Flash .....	82
Center-Weighted Fill-Flash .....	82-83
Rear-Curtain Sync Flash Photography .....	84
Multiple Flash Photography .....	85
<b>LENSES</b> .....	86-87
Lens Compatibility Chart .....	86-87
<b>ACCESSORIES</b> .....	88-101
INTERCHANGEABLE VIEWFINDERS .....	88-89
INTERCHANGEABLE FOCUSING SCREENS .....	90-91
Focusing Screen Selector Guide .....	91
POWER SOURCES .....	92
OPTIONAL SPEEDLIGHTS .....	93
OPTIONAL CAMERA BACKS .....	94-95
VIEWING ACCESSORIES .....	96-97
CLOSE-UP ACCESSORIES .....	98-99
REMOTE CONTROL ACCESSORIES .....	100-101
<b>CAMERA CARE TIPS</b> .....	102-103
<b>NOTES ON BATTERIES</b> .....	104-105
<b>SPECIFICATIONS</b> .....	106-109

## FOREWORD

Thank you for purchasing the F4. We're sure it will make photography more exciting and rewarding than ever.

With a wealth of exciting new features, the Nikon F4 is designed to be as up to date as you are in your approach to photography. Ultra-fast autofocus, versatile Matrix Metering, Matrix Balanced Fill-Flash, an unprecedented fast shutter speed of 1/8000 sec. and flash sync speed of 1/250 sec., top film advance speed of 5.7 fps, are just the beginning of what you'll discover in this ergonomically designed camera. At the same time, the F4 retains compatibility with virtually all Nikon lenses present and past, and a great many of the accessories and attachments that make the Nikon System the most comprehensive in all 35mm SLR photography.

We would like to think that the F4 is not only the fruit of Nikon's commitment to perfection, but is also Nikon's joint creation with everyone committed to fine photography, including yourself.

Get to know your F4, but before using it, be sure to read this manual thoroughly.

\*For F4 series cameras, Nikon offers two versions — Nikon F4s with High Speed Battery Pack MB-21 containing six AA-type batteries, and Nikon F4 with Battery Pack MB-20 containing four AA-type batteries.

# NOMENCLATURE

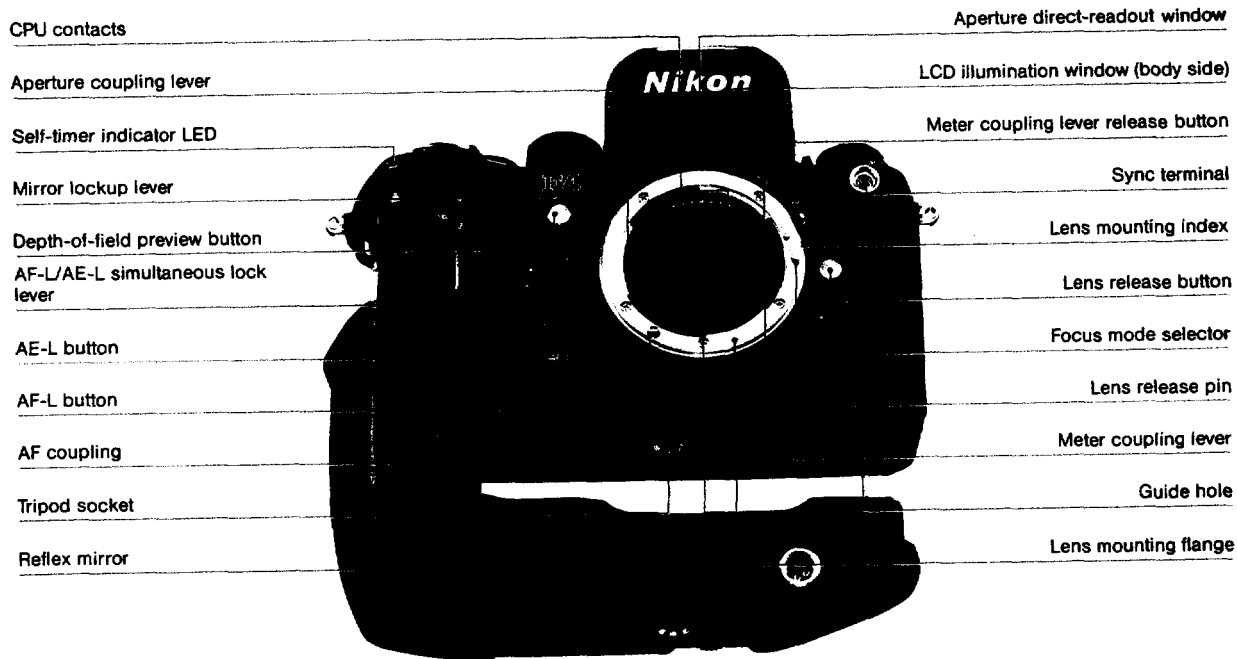

Film advance mode index

Shutter speed dial lock release

Viewfinder illuminator switch

Finder release lever

Camera back lock lever

Film speed dial lock release

Film rewind crank

Film rewind knob

Alert LED

Shutter speed dial

Film rewind lever (R1)

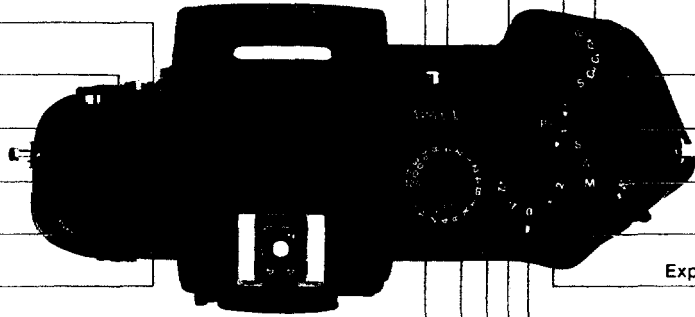

Shutter release button

Film advance mode selector

Film advance mode selector  
lock release

Exposure mode selector

Frame counter

Multiple exposure lever

Exposure compensation lock lever

Exposure compensation index

Exposure compensation dial

(R1) lock button

(R2) lock button

Film rewind lever (R2)

Film speed dial

Camera strap eyelet

Film rewind fork

DX contacts

Film cartridge chamber

Release terminal

Shutter curtains

Data back contacts

Film guide rails

Film take-up spool

Camera back hinge release

Camera strap eyelet

Film cartridge confirmation window

Film pressure plate

Camera back

Film pressure roller

Film leader index

Film sprocket

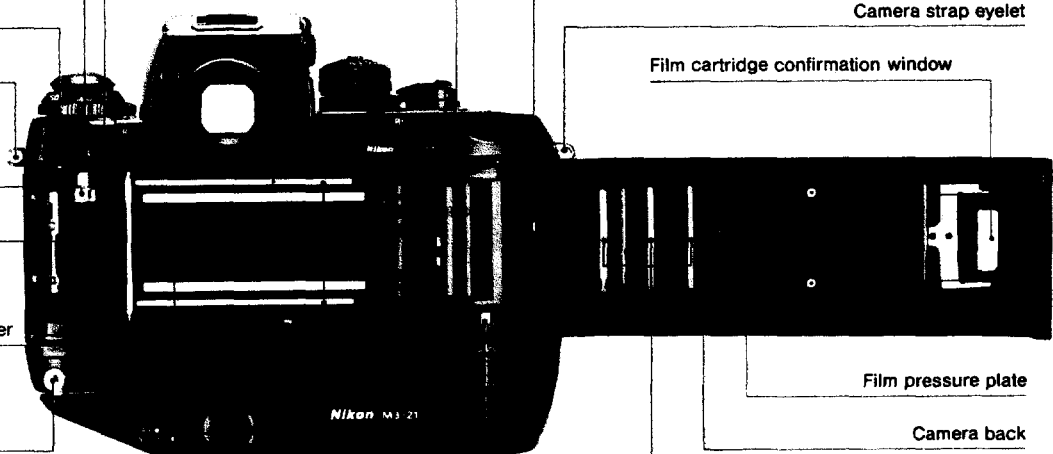

## Multi-Meter Finder DP-20

Accessory shoe

Eyepiece shutter lever

Viewfinder eyepiece



Metering system selector

Compensation value scale window

Shutter speed/metering system index

Diopter adjustment knob

LCD illumination window  
(finder side)



Exposure compensation dial  
for focusing screens





# VIEWFINDER INFORMATION

ADR (Aperture Direct-Readout)

Focus indicators

Frame counter

Flash ready-light signal

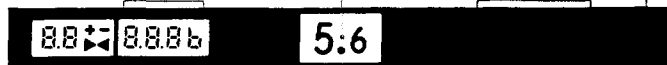

Exposure compensation value

Exposure compensation indicator

## Body side display

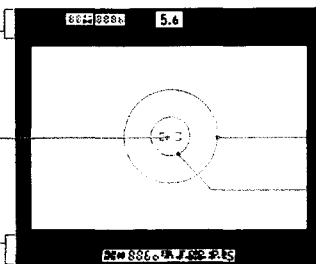

**Note:** This illustration shows all possible display for reference only. During camera use, the actual display will vary, depending on mode.

Focus brackets

12mm-dia. reference circle

5mm-dia. reference circle

## Finder side display

Aperture (P/S), A(A)  
No indication (M)

P(P)  
No indication (S/A/M)

AE-lock indicator

S (S)  
No indication (P/A/M)



Metering system

Electronic analog display (M)  
No indication (P/S/A)

Shutter speed

## High Speed Battery Pack MB-21

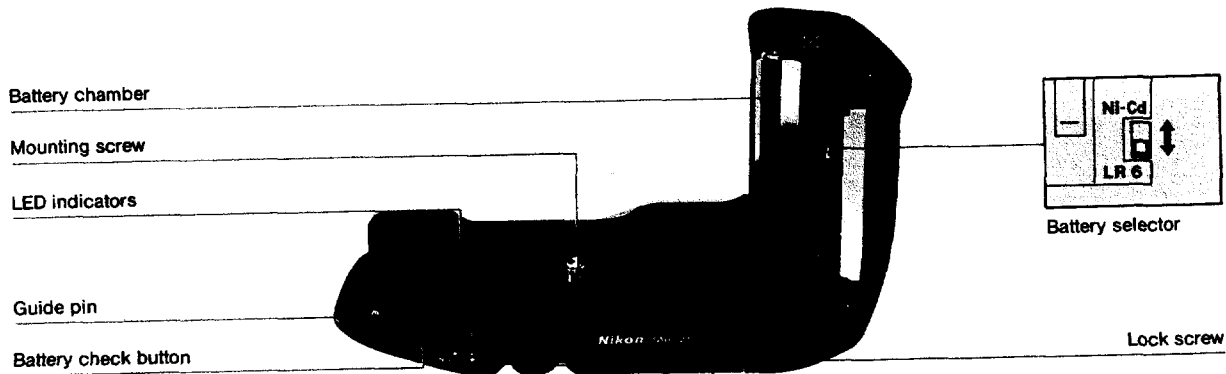
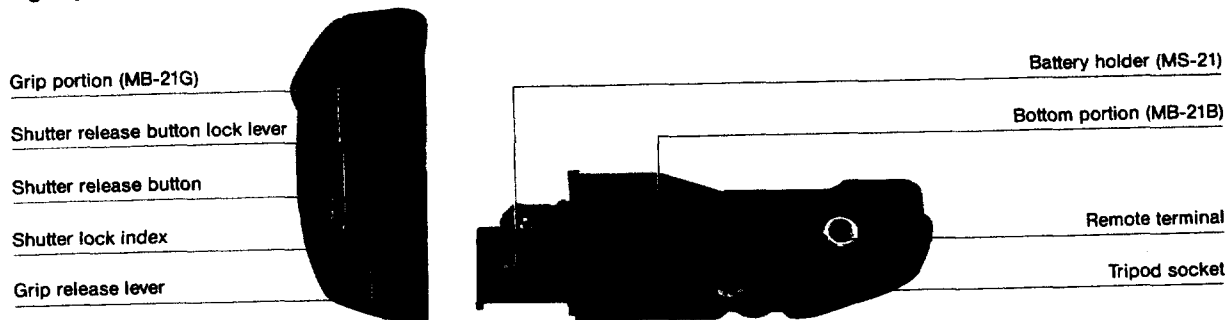

## Battery Pack MB-20

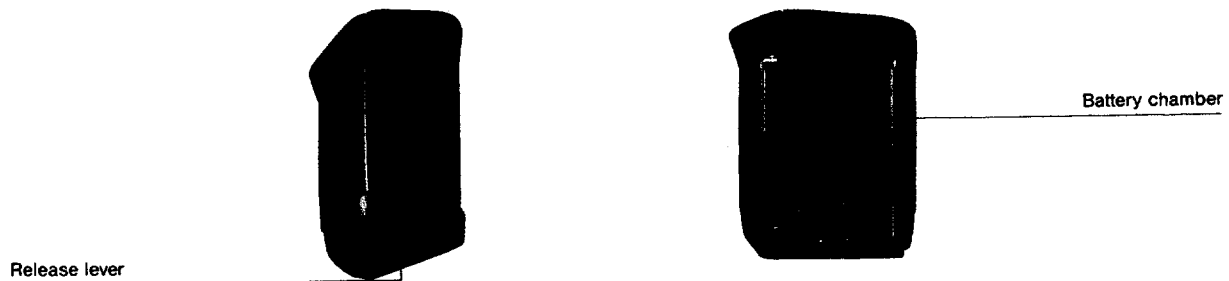

**Lens (AF Nikkor 50mm f/1.4)**

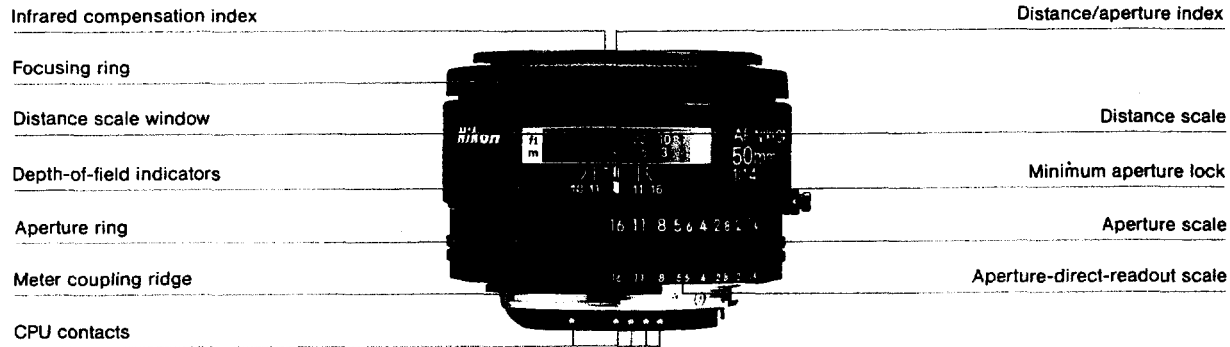

## OPERATION

### MOUNTING THE LENS



Remove body cap and front and rear lens caps.



Twist lens counterclockwise until it securely locks into place, make sure not to touch lens release button.

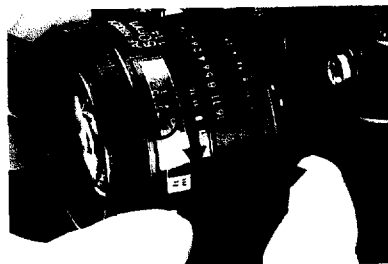

#### To remove

To remove lens, press and hold lens release button and turn lens clockwise.

See page 86 for Nikon lens compatibility chart.

## INSTALLING BATTERIES

### With High Speed Battery Pack MB-21

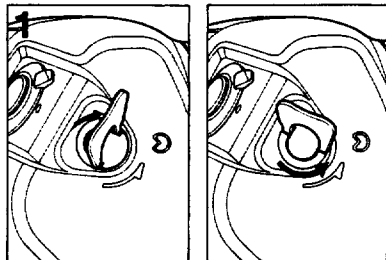

Remove grip (MB-21G) by rotating grip release lever counterclockwise (to  $\odot$ ).

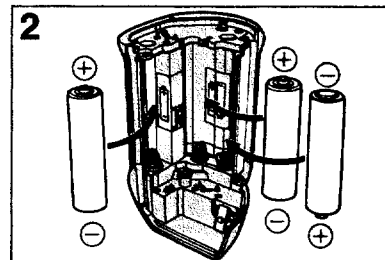
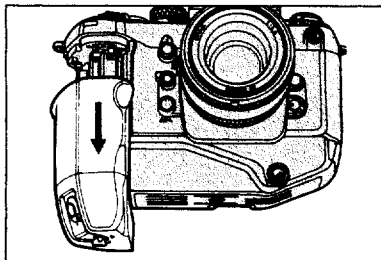

Install three AA-type alkaline-manganese or NiCd batteries with terminals positioned as shown inside grip. Then set the battery selector inside grip to "LR6" for alkaline-manganese batteries, or to "Ni-Cd" for NiCd batteries.

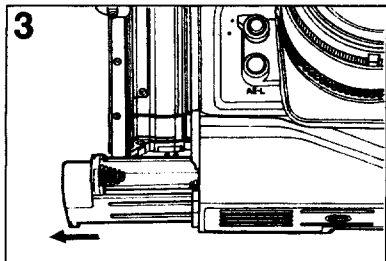

Remove battery holder (MS-21) from bottom portion (MB-21B).

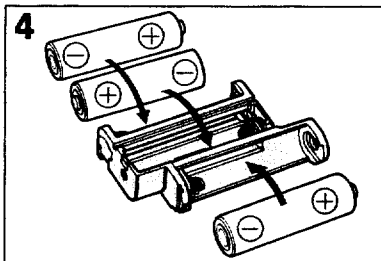

Install three AA-type alkaline-manganese or NiCd batteries with terminals positioned as shown inside battery holder.

- When changing batteries, it is not necessary to remove base from camera body.

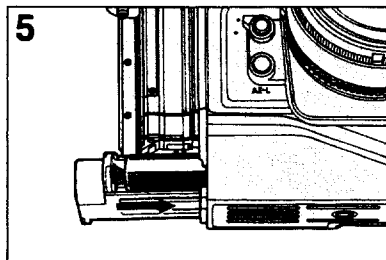

Slide battery holder back into base until it locks into place.

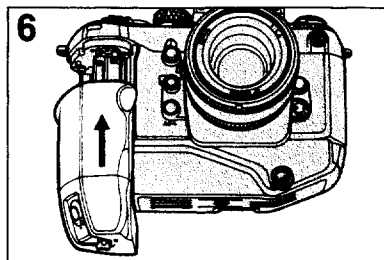

Attach grip to camera body and turn release lever clockwise until it stops.

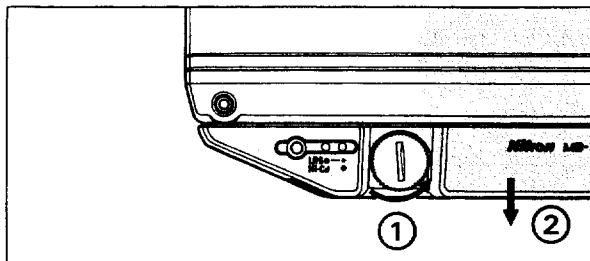
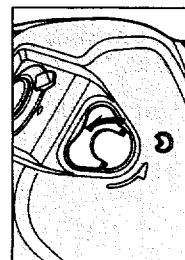
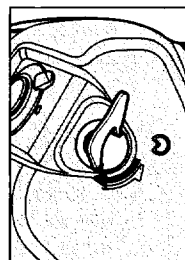

● To remove base from camera body, rotate lock screw counterclockwise using a coin.

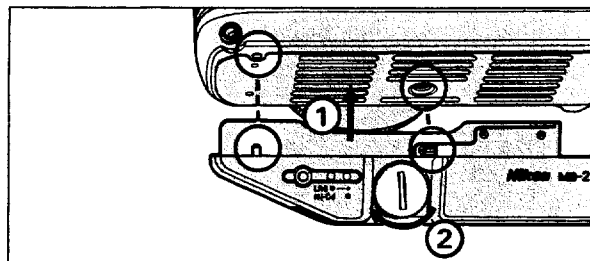

● To attach base to camera body, align mounting screw and guide pin with camera's tripod socket and guide hole, then rotate lock screw clockwise with your fingers. (Do not use a coin, screwdriver etc.)

## With Battery Pack MB-20

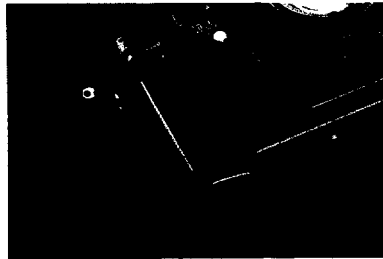

Rotate battery pack release lever counterclockwise (to ☺), and remove battery pack.



Install four AA-type alkaline-manganese batteries with terminals positioned as shown inside battery pack.

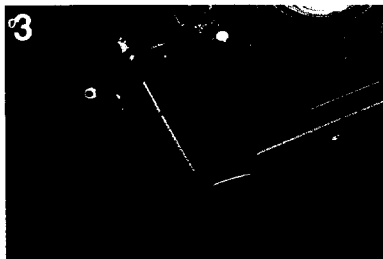

Attach battery pack to camera body and turn release lever clockwise until it stops.

Batteries with a "+" terminal that exceeds 6mm in diameter cannot be used.



## CHECKING BATTERY POWER With High Speed Battery Pack MB-21

At temperatures around 20°C (68°F), AA-type alkaline-manganese batteries give the highest overall performance, including faster advance rates and a greater number of rolls of film. At lower temperatures, however, the performance of alkaline-manganese batteries deteriorates. For shooting at low temperatures, it is advised that you use NiCd batteries. (See table on page 108).

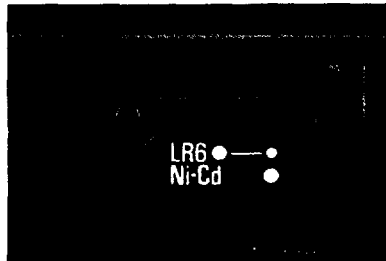

Push the battery check button.  
If both LEDs light up, power is sufficient.

You can also check batteries by confirming that the viewfinder LCD is on, in the same manner as when using the MB-20 (see next page).



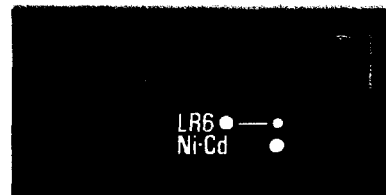

If only one LED comes on, replace batteries.

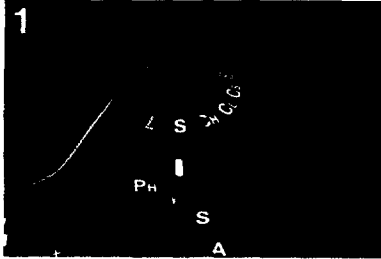

If neither LED lights up, batteries are exhausted or improperly loaded.

## With Battery Pack MB-20



To switch camera on: while pressing lock release, turn film advance mode selector from L (lock) position to S, CH, CL, Cs or .



Next, lightly press the shutter release button and confirm viewfinder LCD appears. LCD stays on for approx. 16 sec. after you take your finger off button. This indicates sufficient battery power.

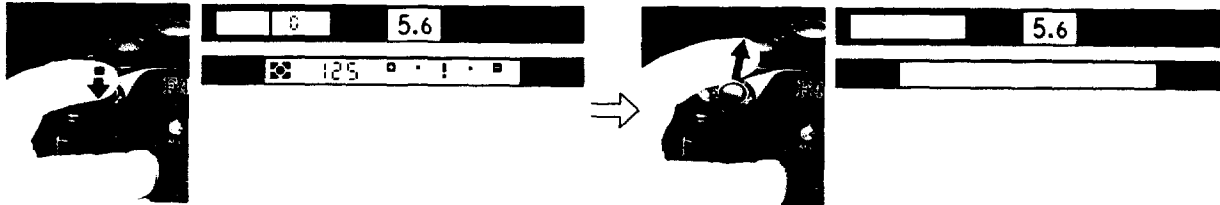
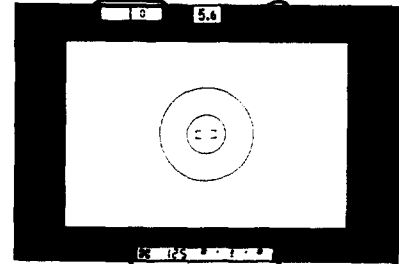

If it turns off immediately after you remove your finger from the button, replace batteries.

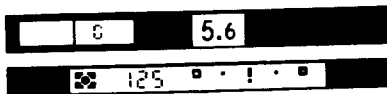

- The batteries operate both auto-focus function and camera motor; when operation becomes noticeably slower, change batteries.
- To conserve battery power when not using the camera, be sure to turn film advance mode selector to L.

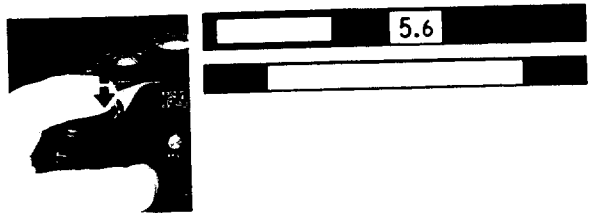

If the shutter does not operate and display does not appear in the viewfinder, batteries are exhausted or improperly loaded.

## LOADING FILM

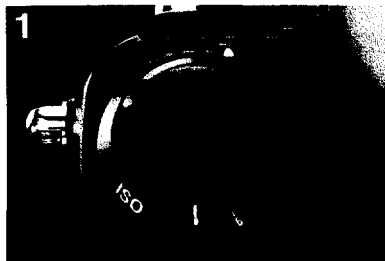

1 With DX-coded film, while pressing lock release, set film speed index at DX.



2 While sliding camera back lock lever, lift film rewind knob. The camera back will pop open.

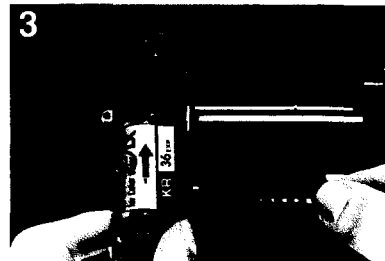

3 Insert film cartridge.

- Usable film speed range for DX-coded film is ISO 25 to 5000.
- With non-DX-coded film, set to appropriate film speed from ISO 6 to 6400. For details on film speed setting, see page 28.

- Do not touch shutter curtains with your finger or with film leader.
- To avoid fogging film (especially high-ISO film), do not load/unload film in direct sunlight.



4 Pull film leader across to red film index mark.

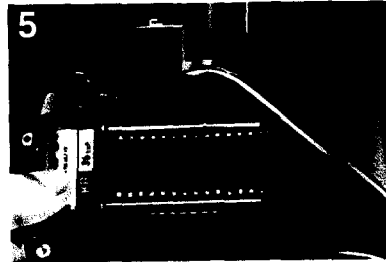

5 Check to ensure film is properly positioned with no slack, and close camera back.

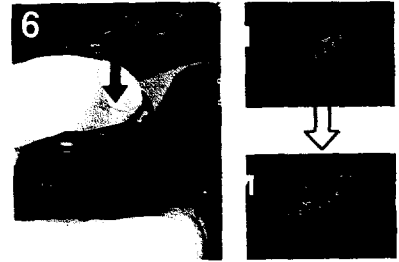

6 Fully depress shutter release button; film automatically advances to frame 1.

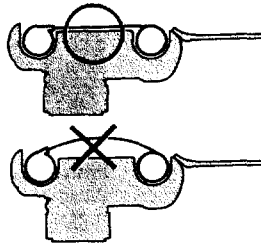

During film loading, shutter does not operate, helping save on battery power. Additionally, the F4 uses a minimum length of film leader, so you can expect to get a full 36 exposures and, often, even more.

## FUNCTION SETTING

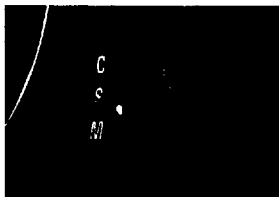

### Focus mode:

Set focus mode selector to M (Manual Focus), S (Single Servo Autofocus) or C (Continuous Servo Autofocus).

For details on focus mode, see page 32.

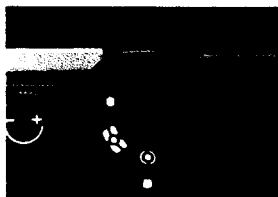

### Metering system (with supplied standard Multi-Meter Finder DP-20):

Set metering system selector to Matrix (☐), Center-Weighted (●) or Spot (•).

For details on metering systems and viewfinder information, see page 44.

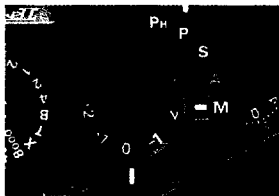

### Exposure mode:

Set exposure mode selector to M (Manual), PH (High-Speed Programmed Auto), P (Programmed Auto), S (Shutter-Priority Auto) or A (Aperture-Priority Auto).

For details on exposure modes and viewfinder LCD, see page 48.

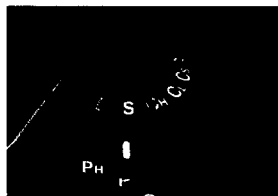

### Film advance mode:

While pressing the lock release, set the film advance mode to S (Single frame), CH (Continuous high speed), CL (Continuous low speed) or CS (Continuous silent).

For details on film advance mode, see page 30.

## SHOOTING

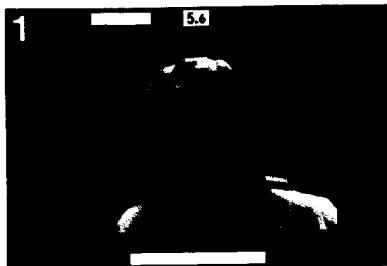

Position viewfinder focus brackets on main subject.

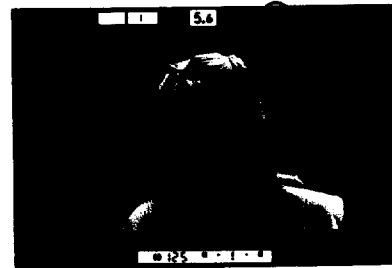

In the manual focus mode, turn the lens focusing ring until the image in the viewfinder appears sharp and/or the electronic range finder in-focus indicator (●) appears.

## 2

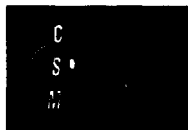

In the autofocus mode, position autofocus sensor area on subject, lightly press shutter release button and confirm in-focus indicator LED (●) appears in the viewfinder. (In Focus Tracking, the in-focus LED does not appear – see page 37.)

Keep your hands off the lens focus ring when the focus mode selector is set to S or C.

If (◀) does not disappear, the subject is closer than the closest focusing distance of the lens in use. Move back from the subject.

In the S (Single Servo Autofocus) mode, the shutter can be released only when the in-focus indicator LED appears; once the LED appears, focus is locked as long as the shutter release button is lightly pressed.

If the subject moves and the focusing distance changes, refocus by briefly removing finger from shutter release button and lightly pressing again to reactivate autofocus operation, or use Continuous Servo Autofocus mode or Focus Tracking. See pages 35 and 37.



**Viewfinder Focusing Screen  
(B-type screen supplied as  
standard)**

Manual focusing is accomplished using either the clear matte field (focus until you see a sharp image) or the Electronic Rangefinder (focus until in-focus indicator is visible). If you choose an optional screen, additional focus and composition aids are available. For details, see page 91.

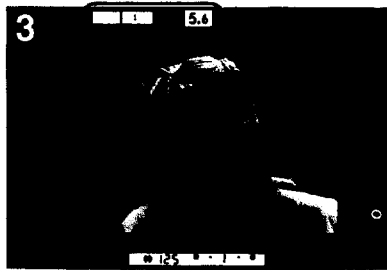

Confirm exposure.  
For details on viewfinder information in each exposure mode, see pages 50 to 58.



Fully depress shutter release button to take a picture. Film will automatically advance by one frame. Viewfinder LCD frame counter advances by 1.

- If any abnormality occurs during film advance, red alert LED blinks and shutter locks. Open camera back and reload film.
- LCD indications turn off approx. 16 sec. after you remove your finger from the shutter release button.

## REWINDING FILM



Film advance stops automatically at end of roll, and red LED lights up.

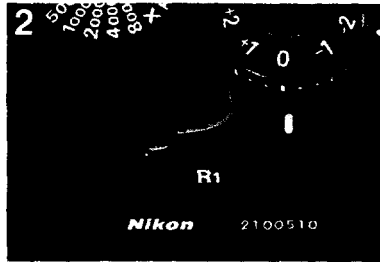

### Power rewind

Turn film rewind levers (R1) and (R2), while pressing respective lock release. This starts film rewinding.

During film rewind, red LED blinks, frame counter counts backward and rewind knob turns. After film rewind stops automatically, red LED turns off.

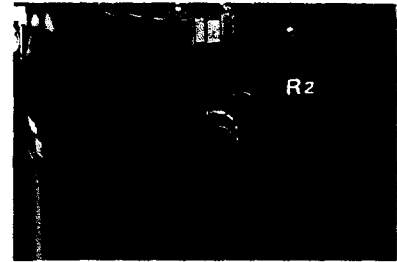

- To rewind film before reaching end of roll, follow the same procedure.
- Releasing the shutter after film rewind resets R1 lever. R2 lever is automatically reset when camera back is opened.

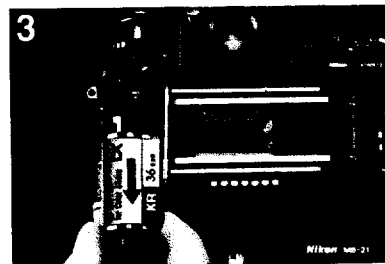
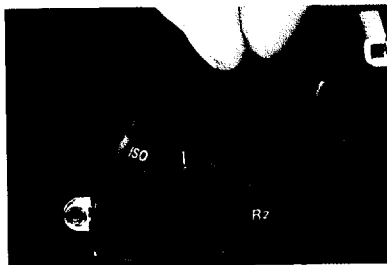
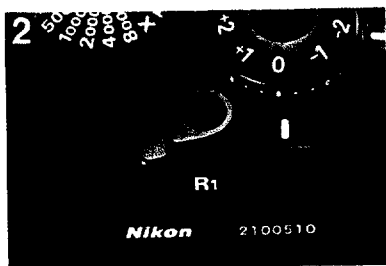

Open camera back and remove film cartridge.

### Manual rewind

To rewind film manually, pull out film rewind lever (R1), lift film rewind crank and turn it in the direction of the arrow until the tension is gone, indicating the film leader is rewound completely back into the cartridge.

Confirm that the R2 lever has returned to original position; if not, move it back into place.

## CONTROLS IN DETAIL

---

### FILM SPEED DIAL

The F4 offers two ways to set film speed, depending on film in use.



#### **DX-Coded Film**

While pressing the lock release, set the film speed dial to DX. Camera automatically senses film speed (ISO 25 to 5000) of installed DX-coded film.



With dial set to DX, use only DX-coded film. If non-DX-coded film or film with a defective DX code is loaded, or no film is loaded, lightly pressing the shutter release button causes the red alert LED to blink, and the shutter locks.

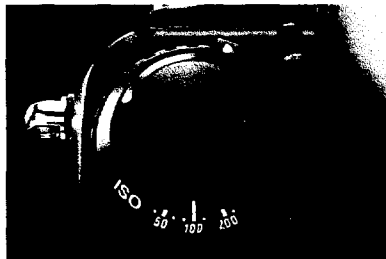

### Manual Film Speed Setting

While pressing the lock release, set the film speed dial to the film's ISO number.

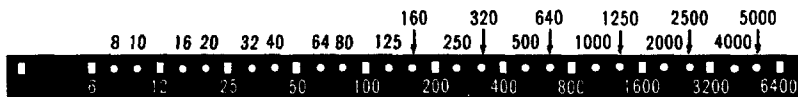

The scale on the dial has numbered settings for speeds from ISO 6 to 6400. Two dots between each pair of ISO numbers stand for intermediate settings. Every position is locked in 1/3 EV steps. The table above shows the speeds for all intermediate settings.

If DX-coded film is loaded, but the film speed is set manually, the camera gives priority to the manually set ISO number.

## FILM ADVANCE MODES

The F4 has four automatic film advance modes.

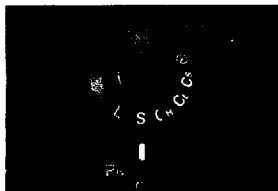

### Single-frame shooting (S)

Fully depressing the shutter release button takes one picture, and immediately advances the film by one frame.

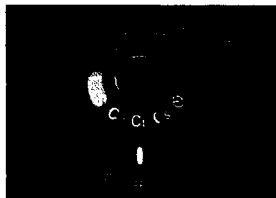
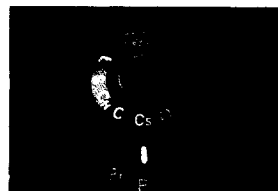
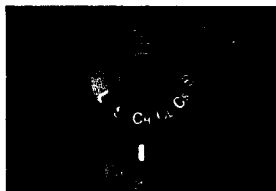

### Continuous shooting (CH, CL, CS)

Shots are taken continuously as long as the shutter release button is depressed. Choose CH (Continuous high speed), CL (Continuous low speed) or CS (Continuous silent). Continuous silent (silent means very quiet environment) is for times when conditions require a minimum of operating noise.

The next table shows film advance speed in each Continuous mode:

	With High Speed Battery Pack MB-21	With Battery Pack MB-20
<b>CH</b>	5.7 frames per second	4.0 fps
<b>CL</b>	3.4 fps*	3.3 fps*
<b>Cs</b>	1.0 fps	0.8 fps

For Continuous Servo Autofocus, with AF Zoom-Nikkor 35-70mm 1/3.3-f/4.5 lens, new AA-type alkaline-manganese batteries, a shutter speed of 1/250 sec. or faster, at normal temperature.

\*Depends on brightness of available light.

- Continuous framing rates may vary with the autofocus mode set to Single Servo because the shutter is released only when the subject is in focus.
- With the autofocus mode set to Continuous Servo, the shutter will fire when you press the shutter release button, regardless of focus status. Autofocus will operate in CL mode when required focus adjustment is minimal. However, if considerable focus adjustment time is necessary, there may not be sufficient time between frames for the required adjustment.
- For prolonged shooting at low temperatures, set the film advance mode to S or CL (except with autofocus mode at Continuous Servo). In these modes, the shutter charging motor and film advance motor are driven sequentially to save battery power.

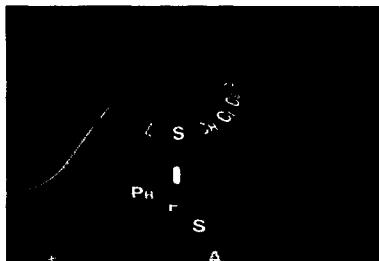

### Mode Selection

While pressing the lock release, rotate film advance mode selector.

Note that the selector includes a self-timer setting (⊙).

## FOCUS MODES

The advanced autofocus system of the F4 works even under extremely low-light conditions — as low as EV **minus 1**. The Electronic Rangefinder operates for both autofocus and manual focusing. Manual focusing can also be accomplished using the clear matte screen or any optional screen with an optical rangefinder. Normally, the Electronic Rangefinder's ability to detect focus is superior to the human eye. However, there are certain subjects that cannot be focused upon in any way — such as shiny metallic subjects, blank walls, etc. In this case, X appears and autofocus with an alternate subject at the same distance or manual adjustment by estimating the distance is recommended.

### Manual Focus with Electronic Rangefinder

Manual focus using the Electronic Rangefinder works with most Nikon lenses, including AF Nikkor when operated manually. (For a complete list of usable lenses, see lens compatibility chart, page 86.) Lenses with a maximum aperture slower than  $f/5.6$  are not suitable for Electronic Rangefinder focusing, even though focus indicator LEDs appear. Focus using clear matte field or change focusing screen to J type.

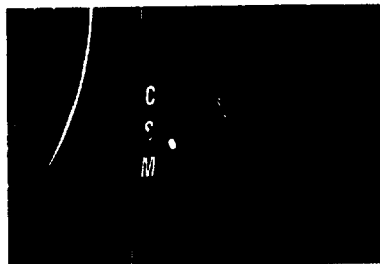

1. Set focus mode selector to M (manual). If lens has an A-M switch, set to M.

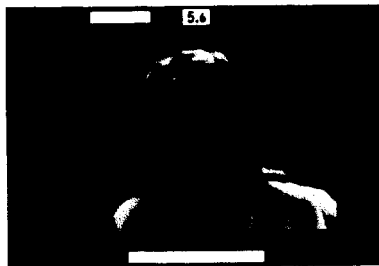

2. Look inside viewfinder and position focus brackets on the main subject. Lightly press shutter release button.



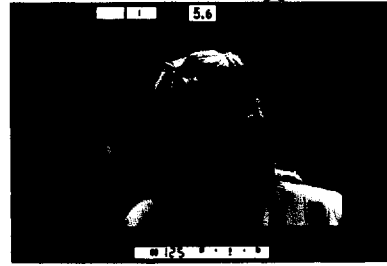
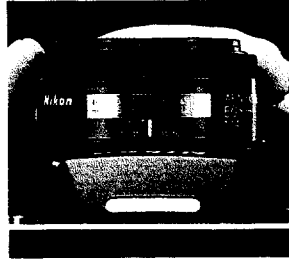
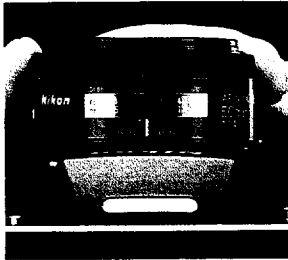

3. Keeping shutter release button lightly pressed, rotate lens focusing ring manually and watch focus indicator LEDs inside the viewfinder.
- If ◀ arrow (rear focus) or ▶ arrow (front focus) appears, manually rotate lens focusing ring in the direction indicated until the in-focus indicator LED appears.
  - If ◀ arrow does not disappear when you turn focus ring counterclockwise to the limit, the subject is closer than the closest focusing distance of the lens. Move away from the subject.

4. Confirm in-focus indicator LED appears, then fully depress shutter release button.

## Manual Focus Using Clear Matte Field

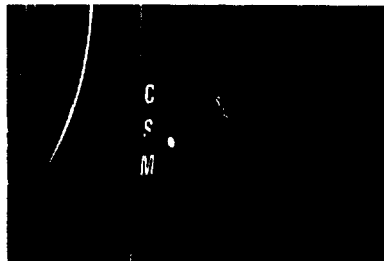

1. Set focus mode selector to M (manual).



2. Focus on subject using clear matte field.

## Autofocus

The F4 provides two autofocus modes — Single Servo Autofocus (S) and Continuous Servo Autofocus (C).

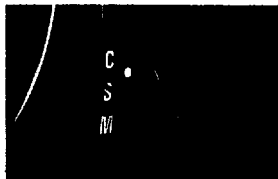
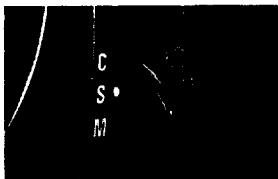

### Single Servo Autofocus (S)

In Single Servo Autofocus mode (S), the shutter cannot be released until the subject is in focus; once the subject is in focus, the focus stays locked for as long as the shutter release button is lightly pressed.

### Continuous Servo Autofocus (C)

The camera continues focusing for as long as you keep the shutter release button lightly pressed. The shutter release button can be fully depressed anytime, regardless of focus status, except when film advance mode selector is set to C.

## Autofocus Operation

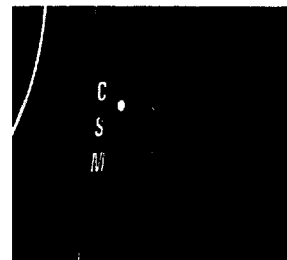
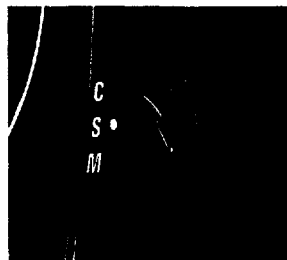

1. Set focus mode selector to either S or C.  
If the lens in use has an A-M switch, set switch to A.

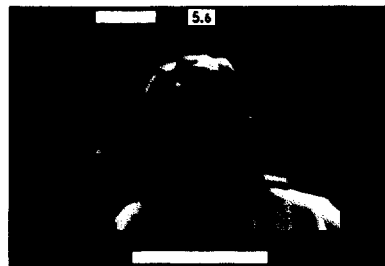

2. Position viewfinder focus brackets on main subject.

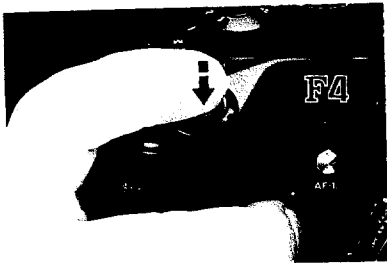

**3.** Lightly press shutter release button to start Autofocus function.

- In continuous shooting (C<sub>H</sub>, C<sub>L</sub>, C<sub>S</sub>) with the autofocus mode set to Single Servo, autofocus operates between exposures for as long as the shutter release button remains depressed. If the shooting distance changes during shooting in C<sub>S</sub> mode, remove your finger from the shutter release button then press to start autofocus again.

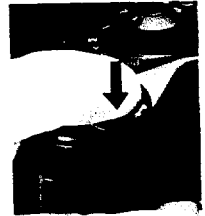

**4.** Confirm the viewfinder in-focus indicator appears, then fully depress shutter release button to take an in-focus picture.

- In Single Servo Autofocus, if in-focus indicator LED does not appear and X appears, shutter locks.
- In Continuous Servo shooting, focusing sharpness depends on subject speed and direction; autofocus may not always operate fast enough to follow certain subjects, so automatic Focus Tracking may be recommended — see page 37.

## Focus Tracking

When shooting a moving subject, with the focus mode set to Continuous Servo Autofocus and the film advance mode to Low-Speed Continuous (CL), Focus Tracking is automatically activated to ensure focused images. In Focus Tracking, the camera analyzes the speed of the moving subject according to focus detection data, and drives the autofocus lens by anticipating the position of the subject at the exact moment of exposure.

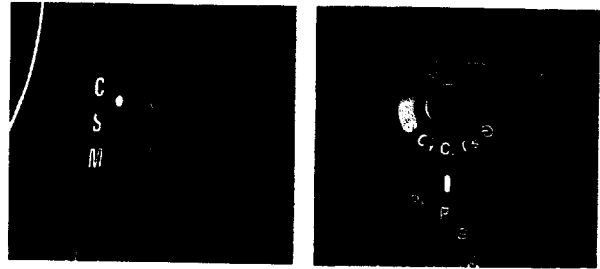

1. Set focus mode selector to C, and film advance mode to CL.

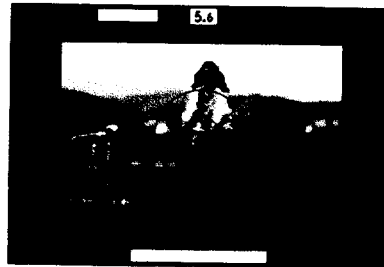

2. Position viewfinder focus brackets on subject.



3. Lightly press shutter release button to start Focus Tracking.

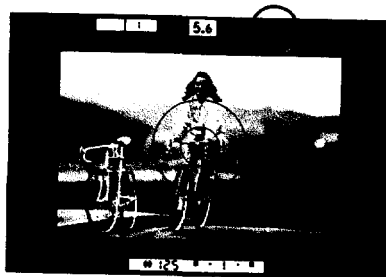

4. Confirm both arrows (▶◀) appear in the viewfinder, then fully depress shutter release button to take an in-focus picture.

- With Focus Tracking, even if the subject is in focus, the in-focus indicator (●) does not appear.
- If the subject speed becomes erratic, Focus Tracking will be automatically deactivated and standard continuous focusing will operate.
- Focus Tracking ability will vary according to subject's brightness and movement, lens in use and shooting distance.
- During Focus Tracking, the subject must remain within the focus brackets.

## Taking Pictures with Main Subject Off-Center Single Servo Autofocus

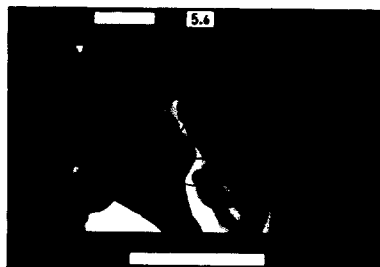

1. Position focus brackets on subject and lightly press shutter release button.



2. Confirm in-focus indicator LED appears in the viewfinder.



3. Keeping the shutter release button lightly pressed, recompose, then fully depress shutter release button.

### Continuous Servo Autofocus

Use AF-L (Autofocus Lock) button.

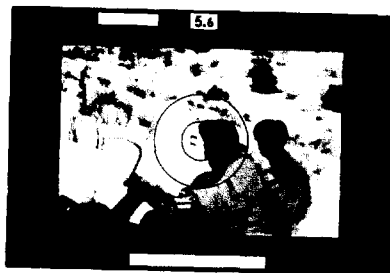

1. Position focus brackets on subject and lightly press the shutter release button.

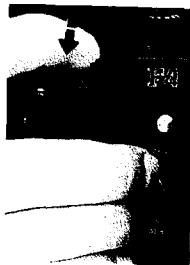
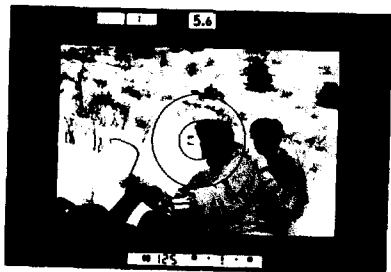

2. Keeping shutter release button lightly pressed, confirm in-focus indicator LED appears, then depress AF-L button and hold in.

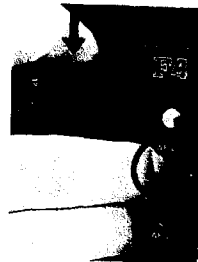
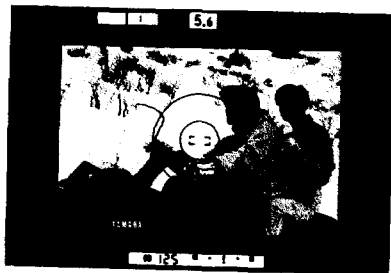

3. With AF-L button depressed, recompose as desired and fully depress shutter release button.



- With the AF-L button depressed, focus will be locked even if you remove your finger from the shutter release button.
- AF-L button can also be used in Single Servo Autofocus mode.



- Simultaneous use of AE-L (Auto Exposure Lock) button is recommended. In this case, turn AF-L/AE-L simultaneous lock lever to (●●) and press AF-L button.

## Special Focusing Situations

To successfully focus, whether using the F4's Electronic Rangefinder, an optical rangefinder, or a clear matte field, the subject must be reasonably illuminated and have sufficient contrast. If the focus-not-possible indicator X appears, manually focus by estimating distance or choose an alternate focus target with the same distance, lock focus, then recompose.

The following situations are examples that are difficult to focus and require greater concentration to secure correct focus.

- 1) When shooting the following:
  - Bright subject with a shiny surface, such as silver or aluminum.
  - Strongly backlit subject.
  - Scene with variety of subjects located at different distances.
- 2) When using a linear polarizing filter, or special filter such as a soft-focus filter. (A circular polarizing filter can be used for autofocus operation.)

R60 (red) and 056 (orange) filters will interfere with Electronic Rangefinder and autofocus operation. When using these filters, focus manually.

---

## Autofocus with Optional Autofocus Speedlights

Although the F4's autofocus works at lighting levels as low as EV minus 1, performance may vary depending on subject detail and contrast. In dimmest light conditions, use Nikon speedlights during AF operation, if it is too dark. The speedlight's AF Illuminator lights up only in the Single Servo Autofocus mode.

1. Mount Nikon Autofocus Speedlight SB-24, SB-23, SB-22 or SB-20 onto the F4's accessory shoe.
  2. Compose picture through viewfinder and lightly press shutter release button.
  3. Speedlight's AF illuminator lights up and autofocus operation begins.
- The focal lengths available when using AF Illuminator with AF Nikkor lenses are 24mm to 105mm.
  - For details, see Nikon speedlight instruction manual.



## Freeze Focus

The optional Nikon Multi-Control Back MF-23 or 250-Exp. Multi-Control Back MF-24, when attached to the F4, offers a Freeze Focus function which automatically fires the shutter when the subject enters a preset focus position. This feature is especially convenient for manual focus with the F4's Electronic Rangefinder. For details, see the MF-23 or MF-24's instruction manual.

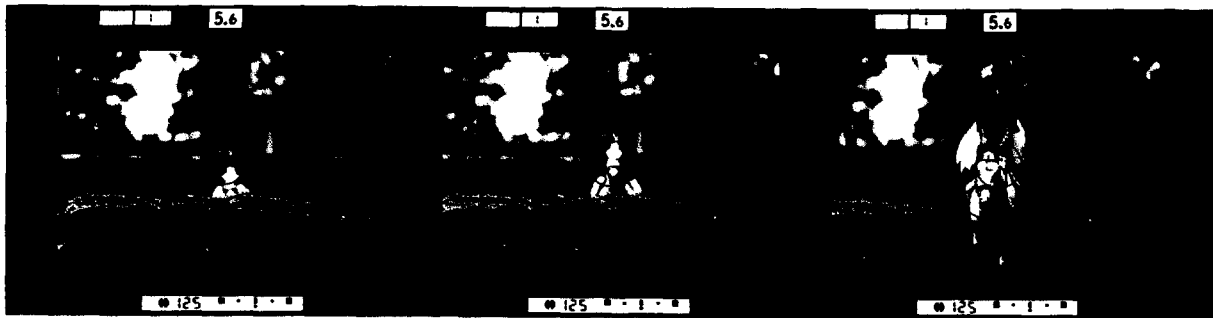
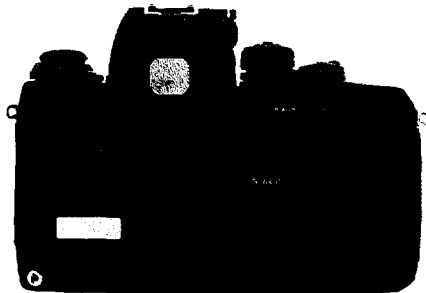

## EXPOSURE METERING SYSTEMS

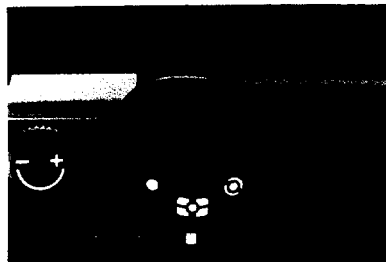

The F4 features three types of exposure metering systems—Matrix, 60/40 Center-Weighted and Spot Metering. When using the Multi-Meter Finder DP-20, the F4's supplied standard finder, you can select either of three metering systems by setting the finder's selector to (☼) for Matrix, (●) for Center-Weighted and (•) for Spot.

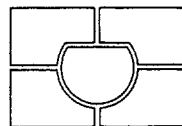

Sensitivity of Five Segments

### **Matrix Metering (☼)**

This system is ideally suited for quick operation and for the most dependable Auto Exposure control. It can also be used for Manual metering and flash exposure control operation with any Nikon TTL speedlight.

In Matrix Metering, the meter automatically provides the main subject with correct exposure in virtually any lighting situation, without the need of manual exposure compensation. The Matrix Metering sensor determines scene brightness by dividing the scene into five areas, analyzing each area for brightness and scene contrast.

This metering system is available with the F4's supplied standard Multi-Meter Finder DP-20.

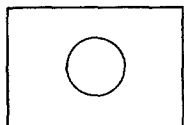

**Sensitivity of Center-Weighted  
Metering**

### **Center-Weighted Metering (☉)**

Choose Center-Weighted Metering when you want to base exposure on either Auto or Manual Exposure control for a centrally located subject. Selecting Center-Weighted Metering overrides Matrix Metering and concentrates 60% of the meter's sensitivity into the center of the viewfinder which is outlined by a 12mm circle.

This metering system is available with the F4's supplied standard Multi-Meter Finder DP-20 and the optional AE Action Finder DA-20.

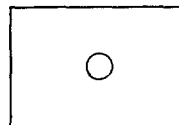

**Sensitivity of Spot Metering**

### **Spot Metering (•)**

For selective metering of tiny subjects or for advanced manual metering techniques, use Spot Metering.

The area metered is represented by the approx. 5mm-diameter circle in the center of the viewfinder. This metering system is effective when precise measurement of a special portion of the subject is required. The spot metering sensor is incorporated in the F4's body, so Spot Metering is available with any of the F4's interchangeable viewfinders.

## Metering System Selection

Set the metering system selector to either Matrix, Center-Weighted or Spot Metering, and confirm respective mark appears in the viewfinder LCD. For available lenses for each metering system, see page 86.

### Matrix Metering

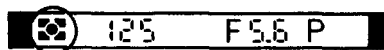
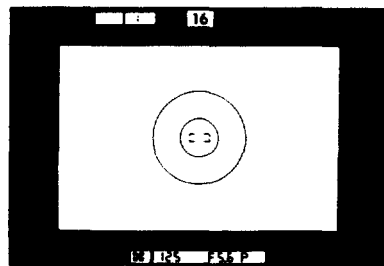
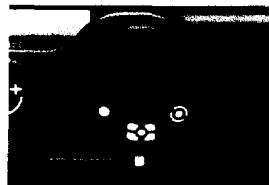

### Center-Weighted Metering

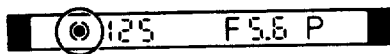
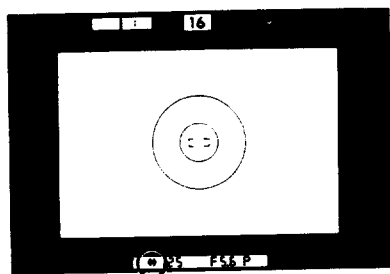
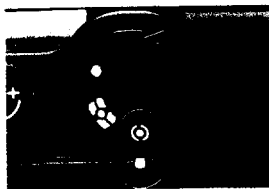

### Spot Metering

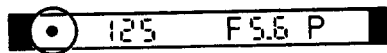
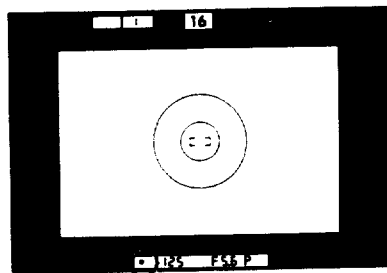
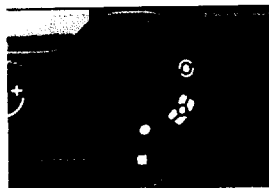

## EXPOSURE MODES

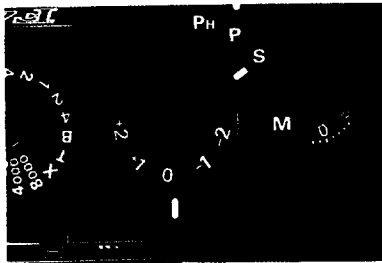

The F4 offers Manual (M), two Programmed Auto (PH, P), Shutter-Priority Auto (S) and Aperture-Priority Auto (A) Exposure modes.

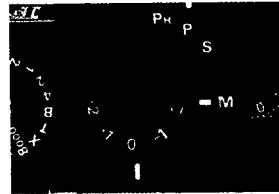

### Manual Exposure Mode

In the Manual Exposure mode, both shutter speed and aperture can be set manually to achieve the desired effect. Use fast shutter speeds to stop the action, slower speeds to create motion effects or fuzzy outlines. Manually setting the exposure mode also lets you control depth of field, either by softening the background so the main subject of the picture stands out, or by creating overall uniform sharpness.



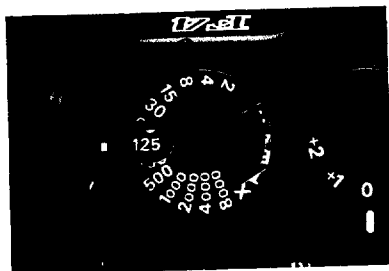

1. Set any of the click-stopped shutter speeds on the shutter speed dial (4 sec. to 1/8000 sec.); the lens aperture ring may be continuously adjusted (i.e., intermediate f/stops are usable).

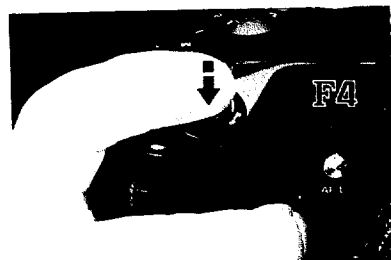
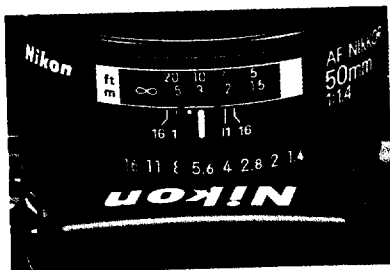

2. Lightly press shutter release button.



3. Adjust aperture and/or shutter speed referring to the Electronic Analog Display in the viewfinder LCD.  
The Electronic Analog Display range is +2EV to -2EV, in increments of 1/3EV.

**With Multi-Meter Finder DP-20**



Correct exposure



Overexposure by 1-2/3 EV



Underexposure by 1EV

**With other finders**

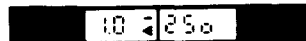

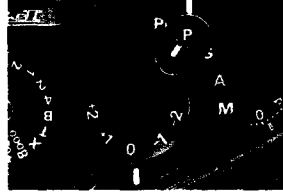
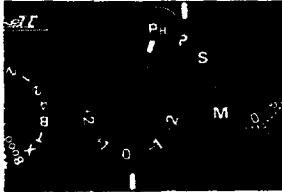

### Programmed Auto Exposure Modes (P<sub>H</sub>, P)

Programmed auto operation is ideal for quick operation and is the simplest method for exposure control. Together with Matrix Metering, it is very reliable.

Programmed Auto Exposure modes can only be used with lenses having a built-in CPU such as AF-Nikkor lenses and the Nikkor 500mm f/4 P. For lenses without a CPU, exposure mode is automatically set to Aperture-Priority Auto (A). Setting the exposure mode to **P<sub>H</sub> (high-speed program)** or **P (normal program)** lets you choose normal or high-speed program. For a higher shutter speed, such as when using a telephoto lens, or for shooting a fast-moving subject, P<sub>H</sub> is recommended.

### Dual Program Chart (e.g., 50mm f/1.4, ISO 100)

The EV (Exposure Value) chart demonstrates the difference between the F4's normal and high-speed programs. Follow either colored line to where it intersects a diagonal line. This shows the combination of aperture (vertical line) and shutter speed (horizontal line).

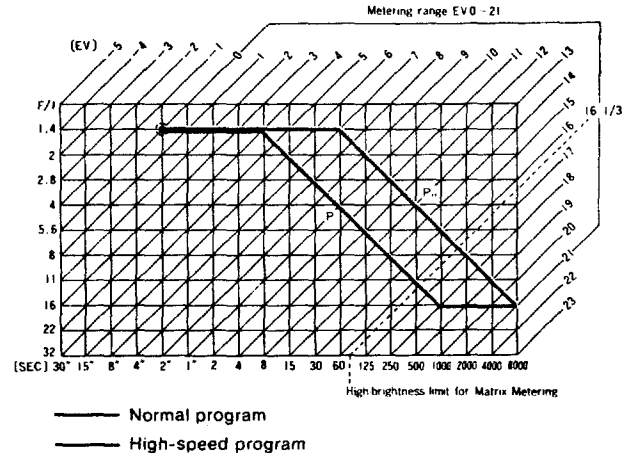

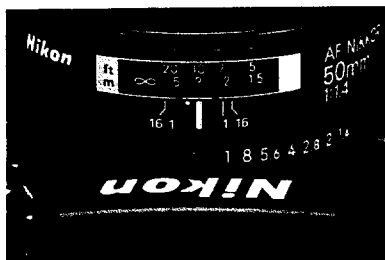

1. Set lens to its minimum aperture (largest f-number).  
With AF Nikkor lenses, lock lens aperture ring at its minimum setting. (See lens instruction manual.)

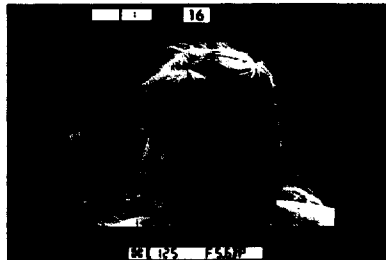
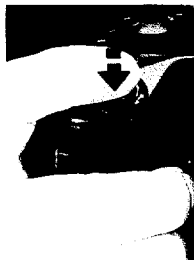

2. Lightly press shutter release button and confirm exposure in the viewfinder.  
Shutter speed is controlled steplessly from 30 to 1/8000 second. Controlled aperture value and shutter speed are steplessly selected. They are indicated in the viewfinder LCD in 1/2 EV steps.

**With Multi-Meter FINDER**

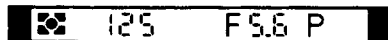

Correct exposure.

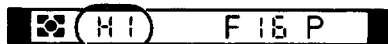

Overexposure; use film with a lower ISO speed or use Nikon ND filter.

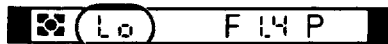

Underexposure; use a Nikon speedlight or use film with a higher ISO speed.



Lens is not set to the smallest aperture setting. Set lens to smallest aperture.



Non-CPU lens is used; automatically shifts to A mode.

**With other finders**

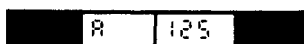
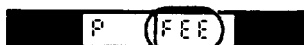
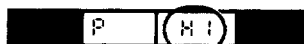

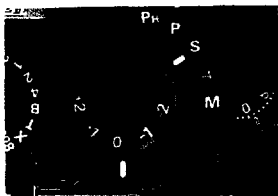

### **Shutter-Priority Auto Exposure Mode (S)**

This mode lets you choose shutter speeds manually. Use a fast shutter speed to stop action, or create motion effects by choosing slower shutter speeds. The F4's microcomputer automatically selects the correct aperture to match the selected shutter speed.

This mode is available with lenses having a built-in CPU such as AF Nikkors and the 500mm f/4 P.



**High shutter speed**



**Low shutter speed**

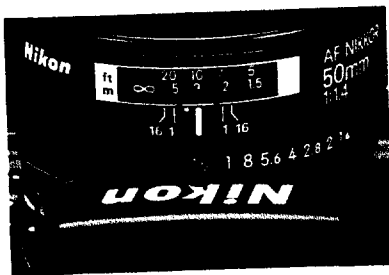

1. Set lens to minimum aperture setting (largest f-number).  
With AF Nikkor lenses, lock lens aperture ring at minimum setting.

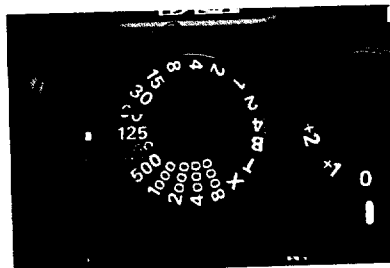

2. Rotate shutter speed dial to select desired shutter speed within the range from 4 to 1/8000 sec. in 1 EV steps. Slower speeds down to 30 sec. are only available in P<sub>H</sub>, P or A mode.

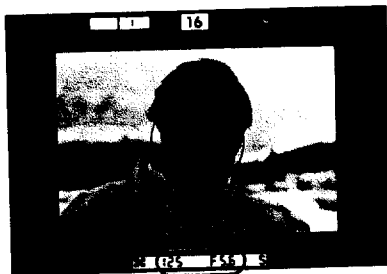

3. Lightly press shutter release button and confirm exposure.  
Aperture is controlled steplessly within the aperture range of the lens and indicated in 1/2 EV steps.

### With Multi-Meter Finder

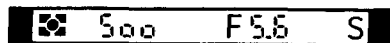

Correct exposure



Overexposure; select higher shutter speed or use Nikon ND filter.

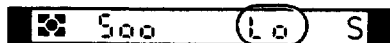

Underexposure; select slower shutter speed, or use a Nikon speedlight.

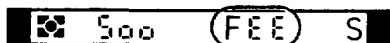

Lens is not set to the smallest aperture setting. Set lens to smallest aperture.

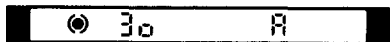

Non-CPU lens is used; automatically shifts to A mode.

### With other finders

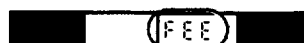
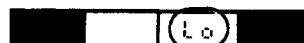
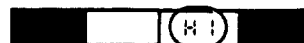
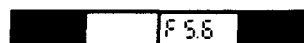



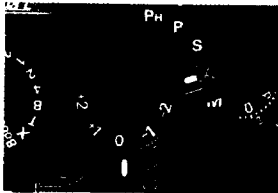

### **Aperture-Priority Auto Exposure Mode (A)**

This mode operates with all Nikon lenses. When used with any optical system such as Reflex lens, microscope, telescope, bellows, etc., the F4's microcomputer automatically selects the correct shutter speed to match the aperture you set. This is the recommended mode when depth of field is your prime consideration. For less distinct backgrounds, as in portraiture, use larger apertures to obtain a shallow depth of field. For overall sharp, clear pictures, as in scenic photography, use smaller apertures.



**Wide aperture**



**Small aperture**

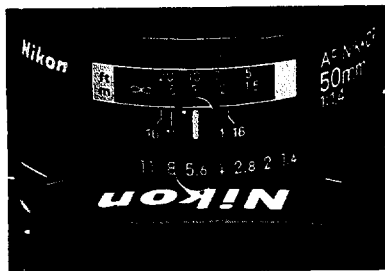

1. Set lens to desired f-number by rotating lens aperture ring.

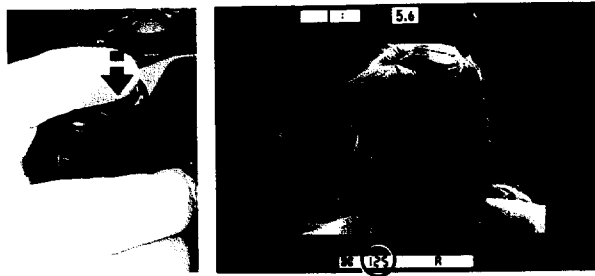

2. Lightly press shutter release button and confirm exposure. Shutter speed is controlled steplessly from 30 to 1/8000 second and indicated in 1/2 EV steps.

#### With Multi-Meter Finder

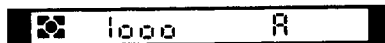

Correct exposure



Overexposure; select smaller aperture setting (larger f-number) or use Nikon ND filter.

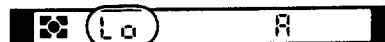

Underexposure; select larger aperture setting or use a Nikon speedlight.

#### With other finders

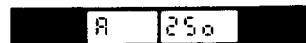

Correct exposure

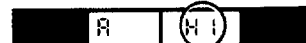

Overexposure; select smaller aperture setting (larger f-number) or use Nikon ND filter.



Underexposure; select larger aperture setting or use a Nikon speedlight.

---

## Stop-Down Exposure Metering

### For lenses and other systems without automatic diaphragms

When the automatic diaphragm ring does not couple with the meter coupling lever of the camera, such as when using a PC-Nikkor reflex mirror or bellows attachment, focusing should be done with the lens wide open while exposure measurement and shooting must be done with the lens stopped down.

In **A** mode:

Take the picture with the lens stopped down. With a PC-Nikkor, correct exposure must be determined before **shifting** the perspective. To do this, first use the AE Lock; the lens can then be shifted to take the shot.

In **M** mode:

Stop down the lens to determine the correct exposure, then take the picture.

### For lenses with fixed apertures

Because the aperture of a Reflex-Nikkor lens is fixed, in photomicrography or telescopic photography, it is impossible to change the exposure by varying the aperture.

In **A** mode:

The F4's computer will automatically adjust the shutter speed. Take the picture by simply depressing the shutter release button.

In **M** mode:

Select the appropriate shutter speed (in 1 EV steps) for correct exposure. If a correct exposure cannot be obtained, use either an ND filter (if the scene is too bright) or supplementary illumination (if too dark).

## EXPOSURE COMPENSATION

### In Automatic Exposure Modes

#### AE-L (Auto Exposure Lock) Button

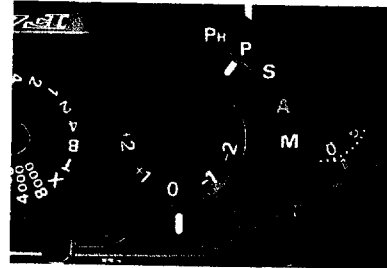
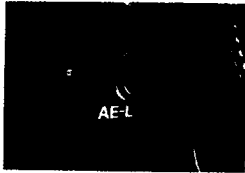

1. Set exposure mode to Programmed (PH, P), Shutter-Priority Auto (S) or Aperture-Priority Auto (A).

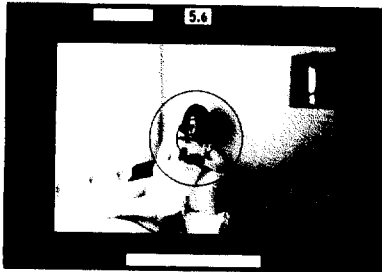

2. Center main subject inside viewfinder or move in closer.

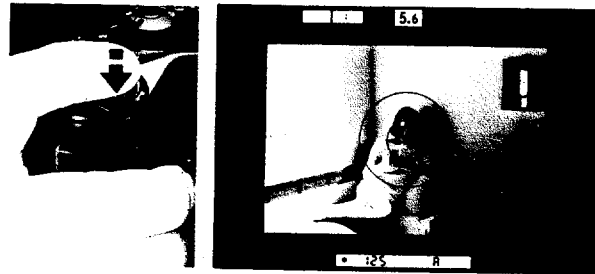

3. Lightly press shutter release button, and confirm shutter speed and aperture in the viewfinder.

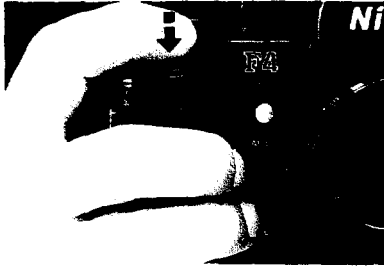

4. While lightly pressing shutter release button, press AE-L button and hold in.

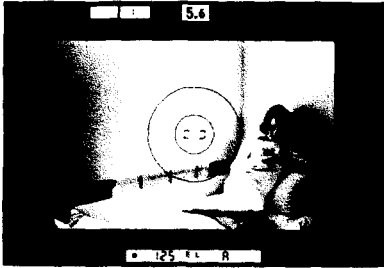

5. Recompose and shoot.

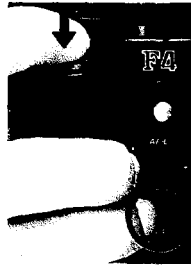

- While exposure is locked, "EL" appears in the viewfinder.
- In Single Servo AF mode, before releasing shutter, be sure to refocus by briefly removing your finger from the shutter release button and lightly pressing again to reactivate autofocus function.
- Simultaneous use of AF-L (Autofocus Lock) button is recommended. In this case, turn AF-L/AE-L simultaneous lock lever to (●●) and press AF-L button.
- This works best with either the Center-Weighted or Spot Metering system; with Matrix Metering, exposure compensation is automatic.

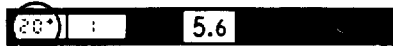
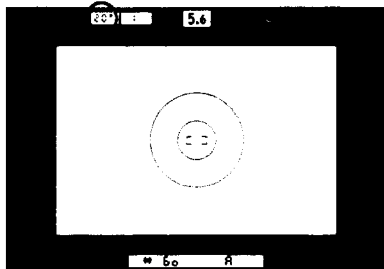
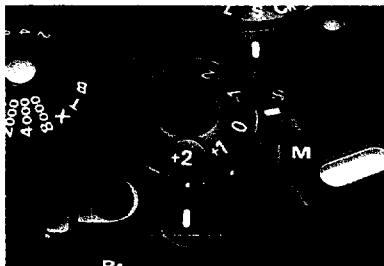

### Exposure Compensation Dial

Using the exposure compensation dial, you can compensate exposure within the range of  $\pm 2\text{EV}$  in  $1/3\text{EV}$  increments.

While sliding the lock release, rotate the exposure compensation dial to set desired compensation value. The dial is graduated in one-third stop increments.  $-1$  and  $-2$  indicate one and two stops underexposure, respectively;  $+1$  and  $+2$  indicate one and two stops overexposure.

Because the exposure compensation mark and value appear in the viewfinder when the shutter release button is lightly pressed, you can set the compensation value with your eye on your subject through the viewfinder.

- After use, reset dial to 0. (■) mark and compensation value disappears.
- Exposure compensation can also be achieved by intentionally readjusting ISO film speed from its actual rating. See page 29.

(In Center-Weighted Metering)



Without compensation

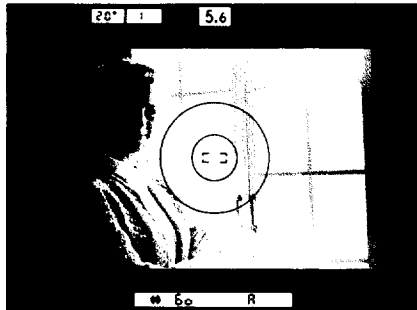

+2EV compensation

Examples:



+2EV



±0EV



-2/3EV

## In Manual Exposure Mode

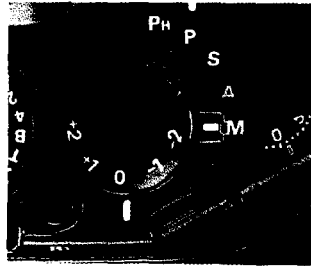

1. Set exposure mode to Manual (M).

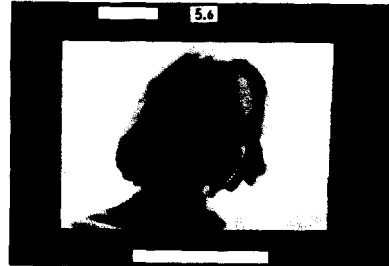

2. Center main subject inside viewfinder, and lightly press shutter release button.

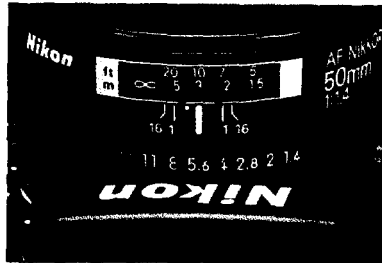
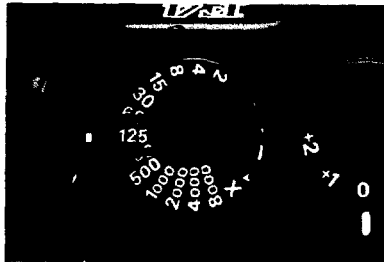

3. Adjust shutter speed and aperture referring to the viewfinder LCD's Electronic Analog Display.



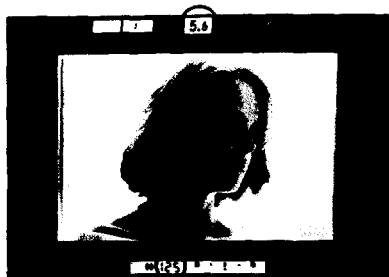

4. Confirm shutter speed and aperture in the viewfinder.

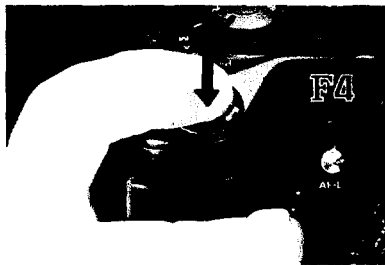

5. Recompose and shoot.

## Auto Exposure Bracketing

By attaching the optional Nikon Multi-Control Back MF-23 or 250-Exp. Multi-Control Back MF-24 to the F4, you can take advantage of auto exposure bracketing to produce a variety of exposures for the same subject, each one suiting specific needs and/or tastes. This feature lets you shoot up to 19 continuous frames, each with a different exposure. For details, see the MF-23 or MF-24 instruction manual.

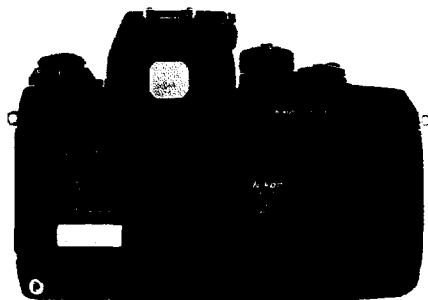

## SHUTTER SPEED DIAL

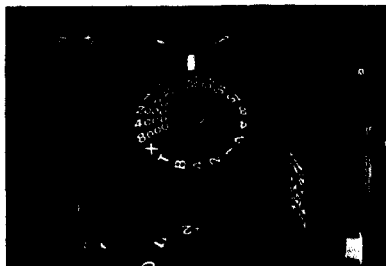

The F4 features an electromagnetically controlled vertical-travel focal plane shutter which consists of four front and four rear curtains.

For Manual and Shutter-Priority Auto Exposure, you can set any of 16 different shutter speeds from 4 sec. to 1/8000 sec. Intermediate shutter speeds cannot be set. Three other settings — B, T and X — are also possible. For P modes and A mode, the shutter operates steplessly from 30 sec. to 1/8000 sec.

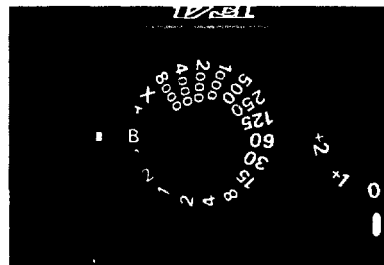

### **B Setting**

At the "Bulb" setting, the shutter remains open as long as the shutter release button remains depressed. This setting should be used only in the Manual Exposure mode. Set shutter speed dial to B.



## DEPTH-OF-FIELD PREVIEW BUTTON

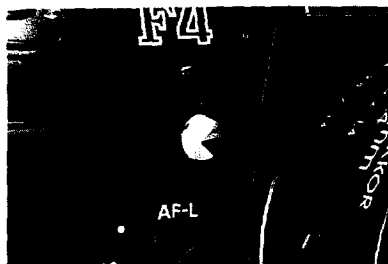

When a lens with an automatic diaphragm is used, the viewfinder image is viewed with the lens at maximum aperture. By depressing the depth-of-field preview button, you stop the lens down to the aperture set, enabling you to examine depth of field before shooting. The viewfinder image normally darkens as the aperture gets smaller. Portions of the picture that appear in focus when the button is pressed are in the zone of sharpest focus.

- Depth of field can only be previewed in the Aperture-Priority Auto (A) or Manual (M) exposure modes.
- During preview, autofocus and Electronic Rangefinder operation are not possible.
- During preview with lenses with meter coupler, attaining correct exposure is not possible, because exposure must be determined by full-aperture metering.

---

## METER COUPLING LEVER



Before mounting a non-AI Nikkor lens, be sure to push the meter coupling lever release button and set the meter coupling lever in the "up" position. Then perform stop-down exposure metering (see page 59).

Stop-down exposure metering cannot be performed in Spot Metering.

## MIRROR LOCKUP LEVER

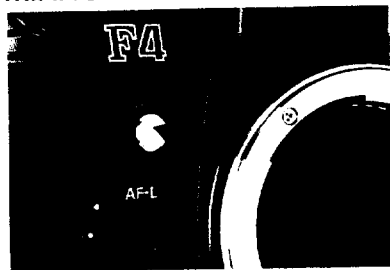

A highly efficient, tungsten-alloy shutter balancer is incorporated in the shutter unit. The balancer operates during shutter operation to overcome vibration normally caused by the shutter curtain in other cameras.

When using super-telephoto lenses or doing photomicrography, it is necessary to reduce camera vibration to the absolute minimum. To lock the reflex viewing mirror in the "up" position, push in the depth-of-field preview button and rotate the mirror lockup lever counterclockwise until it stops.

With the mirror locked up, you cannot operate the camera in any Auto Exposure or autofocus mode, even though the viewfinder LCD may indicate otherwise. Any indication of light by the LCD is a result of spurious light entering through the viewfinder eyepiece.

## SELF-TIMER

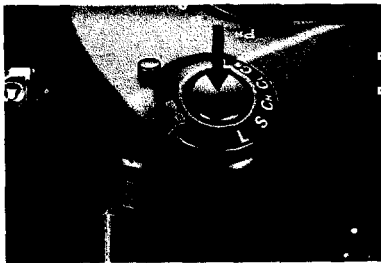
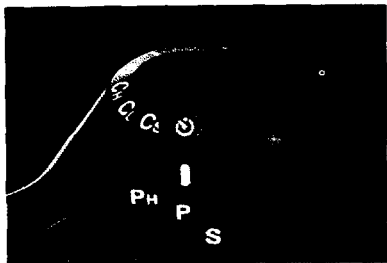

Using the 10-sec. self-timer activates autofocus and light meter operation.

1. While pressing the lock release, set film advance mode selector to self-timer (S) position.
2. Compose picture and confirm focus and exposure.
3. Fully depress shutter release button.  
Self-timer LED starts blinking. During the final two seconds, the LED blinks faster, warning you to get ready.

- To cancel self-timer operation, turn the film advance mode selector to another setting.
- In self-timer operation, the shutter is released whether the subject is in focus or not, even in the Single Servo Autofocus mode, so lightly press the shutter release button first while aiming the camera at the subject to secure correct focus.
- Exposure is continually monitored during self-timer operation until just before the shutter fires. Use of eyepiece shutter or eyepiece cover is recommended.



## MULTIPLE EXPOSURE LEVER

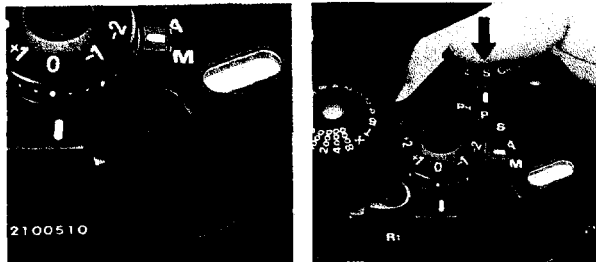

As the name indicates, multiple exposures are two or more exposures of one or more subjects on the same frame.

1. Pull the multiple exposure lever toward you and release the shutter.

*The film will not advance. Multiple exposure lever is automatically reset to the original position.*

2. Depress the shutter release button again to take the second shot.

*Film will advance to the next frame.*

*For more than two shots on the same frame, pull the lever before each additional exposure.*

In continuous film advance modes, pull and hold the lever during exposures. Exposures are taken continuously on the same frame as long as the shutter release button is fully depressed. After the last desired exposure, return the multiple exposure lever to its original position; *unless you cover the lens* before releasing the shutter again, this shot will be the final exposure in the series. The film is then advanced to the next frame.

Note that in multiple exposure operation, exposure compensation is required depending on subject brightness, background brightness and number of exposures. You must determine the necessary exposure compensation and make the adjustment.

To cancel multiple exposure before releasing shutter, push the multiple exposure lever back to the original position.



---

## ALTERNATIVE SHUTTER RELEASE BUTTON

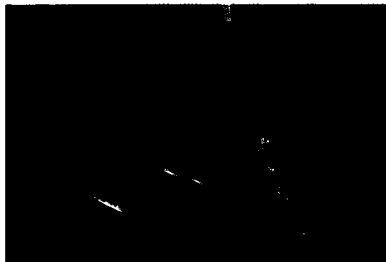

A shutter release button is provided at the bottom of the High Speed Battery Pack MB-21. This is convenient for vertical-format shooting.

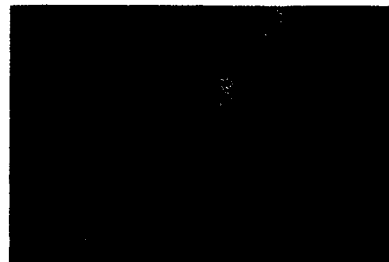

When not using the MB-21's shutter release button, set the lock lever — so the red index is hidden — to prevent unwanted shutter release.

## SYNC TERMINAL

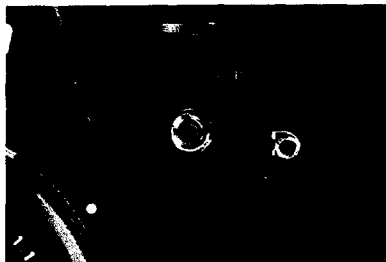

A separate sync terminal is provided on the F4. It accepts all standard PC-type plug-in sync cords, and is threaded for use with a Nikon screw-in sync cord. Use this terminal to attach flash units which do not have the standard ISO hot shoe.

## VIEWFINDER ILLUMINATOR SWITCH

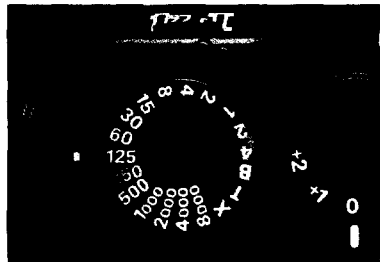

When it's dark, use the viewfinder illuminator to light up all viewfinder information. Turn the switch on, and lightly press the shutter release button to illuminate the display. The illuminator automatically switches off as the viewfinder display disappears; it also momentarily switches off during exposure. Although the illuminator is automatically switched off when the camera is set to the L (lock) position, switch it off, when no longer needed, to conserve power.

## MULTI-METER FINDER DP-20



The Multi-Meter Finder DP-20 is the F4's standard finder.



To remove the finder, push the viewfinder release lever **towards** the finder and, while holding in, slide the viewfinder, away from the lens.

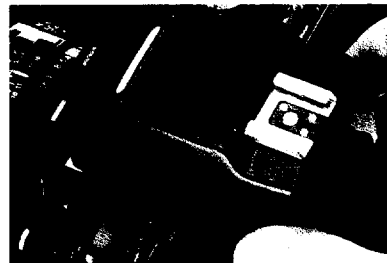

To attach the finder, slide the finder in until it clicks into place.

- Before attaching/detaching the DP-20, make sure the film advance mode selector is set to L.

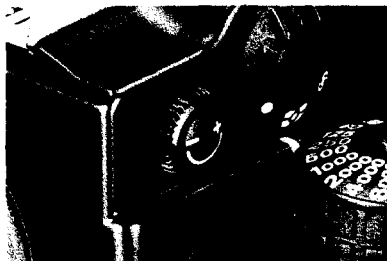

### **Diopter Adjustment Knob**

This knob enables near- or farsighted photographers to adjust eyepiece diopter within a continuous range of from  $-3$  to  $+1$ . Pull the knob and rotate it to either direction until focused image appears sharp, then push back. For diopters beyond this range, Nikon eyepiece correction lenses for F3HP are recommended.

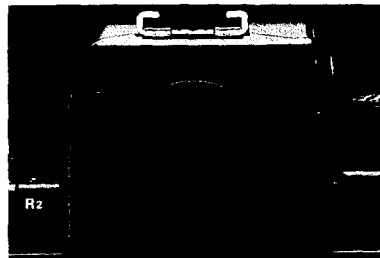

### **Eyepiece Shutter Lever**

During self-timer operation, in automatic exposure modes, use the eyepiece shutter which prevents light from entering the eyepiece and adversely affecting the automatic exposure meter reading. Just turn the lever to the left to close the shutter. The eyepiece shutter is painted red to provide a visual reminder that it's in use.



### **Exposure Compensation Dial for Interchangeable Focusing Screens**

Because the light metering system is incorporated in the finder, it may be necessary to compensate the measured value when using a focusing screen other than the standard interchangeable Advanced Type B BriteView screen provided. Compensation is within the range from  $-2$  to  $+0.5$  EV in  $0.5$  EV steps.

To adjust, remove the finder from the camera body and rotate the screw-like dial with the screwdriver provided, while referring to the compensation value scale window and the instruction manual for the screen concerned.

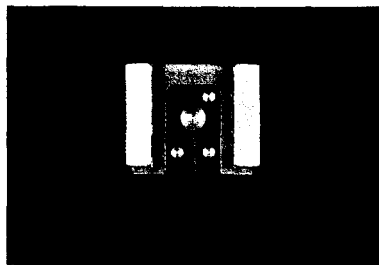

### **Accessory Shoe**

Located at the top of the Multi-Meter Finder DP-20, the ISO-type hot shoe allows direct mounting of a wide range of Nikon dedicated electronic speedlights, including SB-24, SB-23, SB-22, SB-20, SB-18, SB-16B and SB-15. Other Nikon speedlights may be mounted with a compatible Nikon flash unit coupler. Four electrical contacts in the shoe provide the following when used with a compatible Nikon speedlight: proper synchronization of the flash unit, automatic flash output stop, identification of a TTL flash unit, and both viewfinder ready-light indication and automatic switching to the proper sync speeds with Nikon dedicated speedlight units.

# FLASH PHOTOGRAPHY





Matrix Balanced Fill-Flash in daylight



Matrix Balanced Fill-Flash at night

Nikon dedicated electronic speedlights, including SB-24, SB-23, SB-22, SB-20, SB-18, SB-16B and SB-15, take full advantage of the F4's built-in computer, which automatically synchronizes the camera's shutter speed and lens aperture to provide precisely controlled exposures. This means you can perform automatic balanced fill-flash in TTL mode in every flash shooting situation, for beautiful, naturally balanced exposure for foregrounds and backgrounds.

Using automatic balanced fill-flash, the F4 together with a Nikon speedlight allows the photographer a choice of different flash techniques, such as Matrix Balanced Fill-Flash and Center-Weighted Fill-Flash.

		Speedlight setting	SB-24 at TTL 	SB-23/22/20/18/16B/15 at TTL	SB-24 at TTL 
Metering system	Exposure mode				
Matrix Metering	P <sub>H</sub> /P/S/A	Matrix Balanced Fill-Flash			
	M				
Center-Weighted Metering	P <sub>H</sub> /P/S/A	Center-Weighted Fill-Flash			Standard TTL Flash
	M				
Spot Metering					

The Nikon SB-24 Speedlight lets you take advantage of a special photographic technique called rear-curtain sync flash. For details, see page 84.

## Matrix Balanced Fill-Flash in Each Exposure Mode

In **Programmed Auto (P<sub>H</sub>, P)** modes, the sync speed of 1/250 sec. has priority, but when the aperture reaches its largest limit (variable according to ISO film speed), the program line fixes the shutter speed at 1/60 second. Aperture is controlled between f/4 (at ISO 100) and the smallest available lens aperture.

In **Shutter-Priority Auto (S)** mode, you can choose sync speeds from 1/250 to 4 sec., enabling you to shoot, for example, a cityscape of night lights, with automatic flash exposure for foreground subjects. Aperture is controlled between the largest and smallest apertures of the lens.

### Matrix Balanced Fill-Flash in P Mode

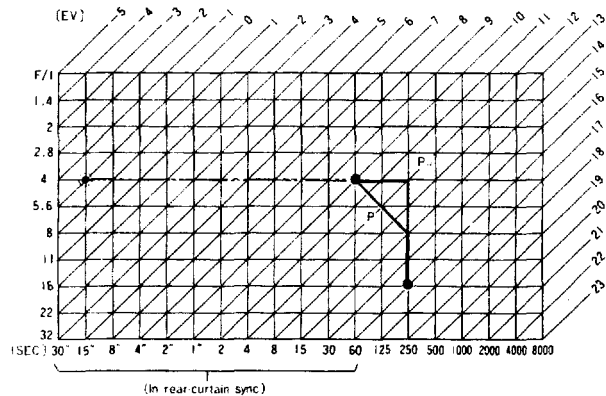

### Matrix Balanced Fill-Flash in S Mode

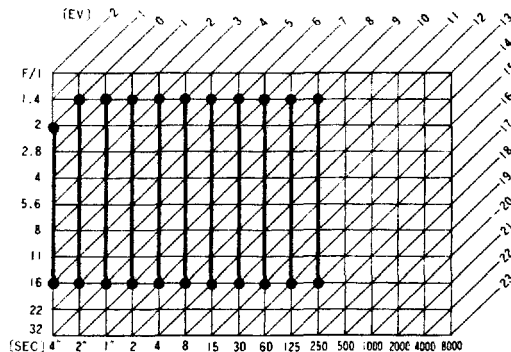



In **Aperture-Priority Auto (A)** mode, you select aperture and the camera selects a suitable sync speed, within a range of 1/60 to 1/250 sec. (at any ISO film speed).

With **Manual (M)**, you control both aperture and shutter speed while the flash exposure is determined by scene brightness and contrast, with Matrix Balanced Fill-Flash control throughout.

- Although the slowest possible shutter speed for front-curtain sync flash photography in TTL mode, with camera at P<sub>H</sub>, P or A, is only 1/60 second, with rear-curtain sync flash photography, the shutter will operate as slowly as 30 seconds, depending on the background brightness.
- In the S and M modes, when you select a shutter speed faster than 1/250 sec., then turn the flash unit ON, the F4 automatically shifts to 1/250 sec.

### Matrix Balanced Fill-Flash in A Mode

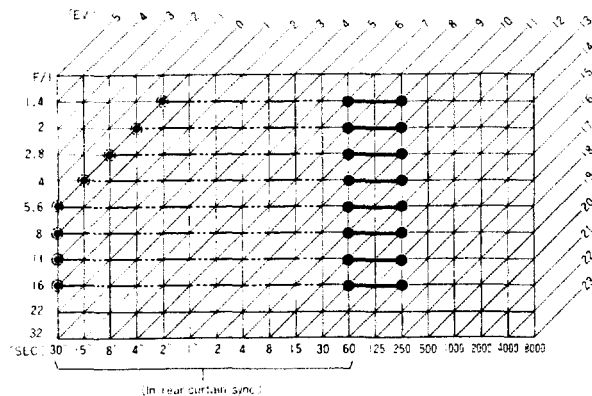

### **Matrix Balanced Fill-Flash**

With the system set to Matrix, Matrix Balanced Fill-Flash is available.

Based on a combination of general scene brightness and contrast, the exposure value for the background is determined by one of five computation methods: Low-Brightness Weighted, Center-Segment, Average, High-Brightness Weighted, or Very-High-Brightness Weighted. Together with the background exposure metering, the F4's microcomputer automatically chooses one from five flash output levels determined by the combination of brightness and degree of contrast. The result is a balanced combination of ambient light and flash illumination that produces a natural-looking and pleasing effect.

### **Center-Weighted Fill-Flash**

For regular TTL flash photography, or to emphasize detailed background areas, use *Center-Weighted Fill-Flash*. In this mode, when the value measured by the center segment is within the controlled shutter speed/aperture range, flash output compensation is automatically set for natural-looking fill-flash photography. (If the value is less than that of the controlled range, standard TTL flash without compensation is selected.)

## Standard TTL Flash

In this mode, although exposure for the background is metered by each metering system, flash output level is not determined automatically. However, you can manually select flash output compensation (on the SB-24) at levels from +1 to -3 EV, for greater personal creativity.

- The usable film speed for TTL flash photography is ISO 25-1000; for non-TTL flash photography, it is 6-6400.
- For details on speedlight operation, see the speedlight instruction manual.
- Use Nikon Speedlights. Other units may damage the camera's electrical circuit due to incompatible voltage requirements, electric contact alignment or switch phase.
- When using a special speedlight with a time-lag provision or when using a speedlight with a long flash duration (i.e., Medical-Nikkor 120mm f/4), adjust shutter speed down to 1/125 sec. or slower.
- When using a speedlight that does not allow automatic sync speed setting, set the camera's exposure mode to Manual.

---

### Rear-Curtain Sync Flash Photography

When using the Nikon SB-24, you can synchronize the flash to the instant just before the rear (second) curtain starts moving. Set the SB-24's flash sync mode selector to "REAR." This lets you turn available light into a stream of light that *follows* the flash illuminated subject. Rear-curtain sync flash photography is especially effective at slower shutter speeds.

In P<sub>H</sub>, P or A mode, shutter will operate as slowly as 30 seconds, depending on the background brightness.



Rear-curtain sync

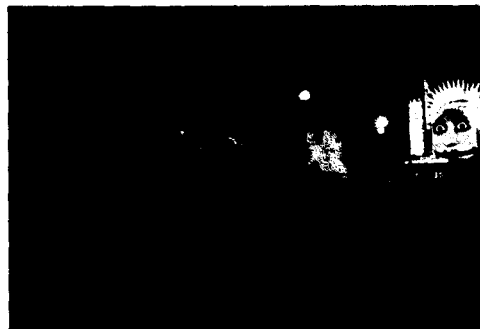

Front-curtain sync

---

## **Multiple Flash Photography**

A number of Nikon speedlights can be used for TTL multiple flash photography, each linked to the F4 via TTL remote or TTL multi-flash sync cord. The camera body's built-in sensor automatically measures and controls the light from all units.

# LENSES

With AF-Nikkor lenses or some other lenses in combination with the TC-16 or TC-16A autofocus teleconverter, the F4 provides full autofocus operation. Full manual focusing, or manual focusing with the F4's electronic rangefinder, is used with virtually all Nikon F-mount Nikkor and Nikon lenses. Use the following table as a guide.

## Lens Compatibility Chart

	Focusing		Exposure mode				Metering system		
	Autofocus	Manual w/electronic rangefinder	Programmed Auto	Shutter-Priority Auto	Aperture-Priority Auto	Manual	Matrix Metering	Center-Weighted	Spot Metering
AF Nikkor lenses (except AF Nikkor lenses for F3AF)	○	○	○	○	○	○	○	○	○
AF Nikkor lenses for Nikon F3AF	○	△ <sup>10</sup>	×	×	○	○	○	○	○
AI-P-type Nikkor lenses	△ <sup>1</sup>	△ <sup>2</sup>	○	○	○	○	○	○	○
AI-type Nikkor lenses (including AI-S)	△ <sup>1</sup>	△ <sup>2</sup>	×	×	○	○	○	○	○
AI-modified Nikkor lenses	×	△ <sup>2</sup>	×	×	○	○	×	○	△ <sup>9</sup>
Non-AI-type Nikkor lenses	×	△ <sup>2</sup>	×	×	△ <sup>8</sup>	△ <sup>8</sup>	×	△ <sup>12</sup>	×
Medical-Nikkor 120mm f/4	×	○	×	×	×	△ <sup>4</sup>	×	△ <sup>12</sup>	×
Reflex Nikkor lenses	×	×	×	×	△ <sup>5</sup>	△ <sup>5</sup>	×	△ <sup>17</sup>	×
PC-Nikkor lenses	×	×	×	×	△ <sup>6</sup>	△ <sup>6</sup>	×	△ <sup>12</sup>	×
AF Teleconverter TC-16A	△ <sup>1</sup>	×	×	×	○	○	○	○	○
AF Teleconverter TC-16*	△ <sup>1, 11</sup>	×	×	×	○	○	○	○	○
AI-S-type teleconverter	×	△ <sup>3</sup>	×	×	○	○	○ <sup>20</sup>	○	○
AI-type teleconverter	×	△ <sup>3</sup>	×	×	○	○	×	○	×
Bellows Focusing Attachment PB-6	×	△ <sup>3</sup>	×	×	△ <sup>7</sup>	△ <sup>7</sup>	×	△ <sup>15</sup>	△ <sup>16</sup>
PK-Series Rings	×	△ <sup>3</sup>	×	×	△ <sup>18</sup>	△ <sup>18</sup>	×	△ <sup>13</sup>	△ <sup>14</sup>
K Ring Set	×	△ <sup>3</sup>	×	×	△ <sup>19</sup>	△ <sup>19</sup>	×	△ <sup>15</sup>	△ <sup>16</sup>

○ Compatible

△ Compatible as per conditions

×

\* Cannot be used with the MB-21, MB-22 or MB-23.

**△** These teleconverters require exposure compensation depending on the lens used. For details, see the teleconverter's instruction manual.

- 1 With maximum aperture faster than  $f/3.5$ , use TC-16A Autofocus Converter. Incompatible with maximum aperture of  $f/3.5$  or slower. (See P.37.)
- 2 With maximum aperture faster than  $f/5.6$ .
- 3 With maximum effective aperture faster than  $f/5.6$ .
- 4 With shutter speed set to  $1/125$  sec. or slower. Flash necessary.
- 5 Aperture cannot be selected.
- 6 Exposure determined by presetting lens aperture. Exposure must also be determined before shifting; in A mode, use AE-L button before shifting.
- 7 Shutter should be released, after exposure measurement, by stopping down PB-6.
- 8 Use stop-down measurement with Type B, E, K, J, or P focusing screen.
- 9 Use full-aperture measurement with maximum aperture of  $f/1.8$  to  $f/2.8$ .
- 10 In Single Servo autofocus mode with lens A-M switch set at M, shutter is not released unless in-focus indicator lights up inside viewfinder.
- 11 Focus lock button on TC-16 cannot be used.
- 12 Stop-down measurement possible. With aperture of  $f/5.6$  or slower, set exposure compensation dial (or focusing screen exposure compensation dial for flash photography) to  $-1$ . With 400mm  $f/5.6$  lens, compensate exposure to  $-1$  when the lens aperture is set at  $f/8$  or slower.
- 13 For full-aperture measurement, set exposure compensation dial (or focusing screen exposure compensation dial for flash photography) to  $-1$ .
- 14 For full-aperture measurement, set exposure compensation dial to  $+1$ .

- 15 In stop-down measurement, set exposure compensation dial (or focusing screen exposure compensation dial for flash photography) to  $-1$ .
  - 16 In stop-down measurement, set exposure compensation dial to  $+1$ .
  - 17 Exposure compensation necessary. (See focusing screen's instruction sheet.)
  - 18 Exposure compensation necessary for full-aperture measurement. (See footnote 13 or 14.)
  - 19 Exposure compensation necessary for stop-down measurement. (See footnote 15 or 16.)
  - 20 When using the TC-301 with Nikkor 400mm  $f/2.8$ , Nikkor 300mm  $f/2.8$  or AF Nikkor 300mm  $f/2.8$  lenses, Matrix Metering cannot be used.
- The following Nikkor lenses cannot be used with the F4s/F4 camera: All 8mm  $f/8$ , 16mm  $f/3.5$  (No. 272281 – 290000), 28mm  $f/3.5$  (No. 301011 – 999999), 35mm  $f/1.4$  (No. 385001 – 400000), all 55mm  $f/1.2$ , all old-type Reflex 1000mm  $f/6.3$ , all 21mm  $f/4$ , all old-type PC 35mm  $f/3.5$ .
  - The AF Teleconverter TC-16 (for F3AF) cannot be attached to the F4s camera.
  - To attach an old-type Reflex-Nikkor 500mm  $f/8$  to an F4s camera, turn the lens' tripod mounting collar so it faces the direction opposite the camera's grip (from the front of the camera, it should face the right-hand side). To change the camera/lens assembly from horizontal to vertical position or vice versa, do not turn the assembly; turn the tripod head.

## ACCESSORIES

### INTERCHANGEABLE VIEWFINDERS

In addition to the standard Multi-Meter Finder DP-20, the F4 accepts various other interchangeable viewfinders. To remove the finder (see page 76), turn the viewfinder release lever and slide the finder toward you. To attach the finder, slide the finder as far as it goes.

The chart below shows the combination of viewfinders and metering systems.

Finder	Metering system	Matrix	Center-Weighted	Spot
Multi-Meter Finder DP-20		○	○	○
AE Action Finder DA-20		×	○	○
6X High-Magnification Finder DW-21		×	×	○
Waist-Level Finder DW-20		×	×	○

### AE Action Finder DA-20

Perfect for situations where normal viewing is difficult or impossible, such as when wearing a helmet or goggles, or with the camera encased in a special housing for underwater photography. Rubber hood and rubber eyepiece cover are provided.





---

### **6X High-Magnification Finder DW-21**

For critical high-magnification close-up work and photomicrography. Its sophisticated optical system provides a clear, sharp view of the entire image at full approx. 6X magnification. Fitted with a -5 to +3 diopter adjustment for individual eyesight correction, plus a rubber eyecup and rubber eyepiece cover.

### **Waist-Level Finder DW-20**

For use when the F4 is used at a low angle or on a copystand. Fold-up-type viewing hood provided. The built-in flip-up magnifier provides an approx. 5X magnification on the center of the image for accurate focusing.



DW-21



DW-20

## INTERCHANGEABLE FOCUSING SCREENS

Nikon offers you a choice of 13 interchangeable focusing screens. The advanced B-type BriteView screen is supplied with the F4 as standard equipment. The following is a chart listing all interchangeable screens.

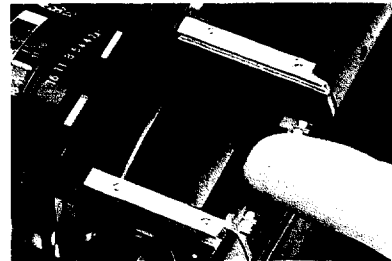

**To remove the focusing screen**, first remove the finder, then insert your fingernail under the rear edge of the screen and lift it out.

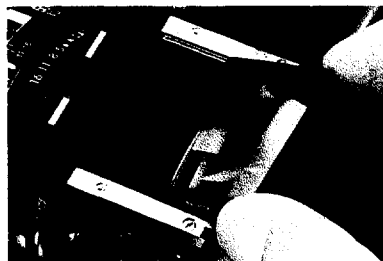

**To install a screen**, simply insert the front edge under the central ridge, and push the rear edge down into place.

## Focusing Screen Selector Guide

### Type B



Matte/Fresnel field with 5mm-dia. and 12mm-dia. reference circles and focus brackets. Good for general photography.

### Type U



Matte/Fresnel field with 5mm-dia. and 12mm-dia. reference circles and focus brackets. Suitable with telephoto lenses longer than 200mm.

### Type F



Matte/Fresnel field with 5mm-dia. and 12mm-dia. reference circles and focus brackets. Suitable with reflex lenses and telephoto lenses longer than 400mm.

### Type C



Fine-ground matte field with 5mm-dia. clear spot and cross hair. For photomicrography, astrophotography and other high-magnification applications using parallax focusing on aerial images.

### Type M

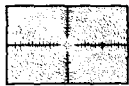

Fine-ground Fresnel field with 5mm-dia. clear spot and cross hair for use in parallax focusing on aerial images, plus millimeter scales for calculation of individual magnification of objects or for measuring objects. Brilliant image in dim light. Suitable for close-ups, photomicrography and other high-magnification applications.

### Type E

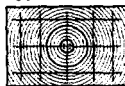

Matte/Fresnel field with 5mm-dia. and 12mm-dia. reference circles, focus brackets and etched horizontal and vertical lines. Ideal for architectural photography.

### Type J



Matte/Fresnel field with central 5mm-dia. microprism focusing spot and 12mm-dia. circle. Good for general photography.

### Type K

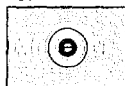

Matte/Fresnel field with 3mm-dia. BriteView split-image range finder spot surrounded by 1mm-wide microprism doughnut. Rapid and accurate focusing for subjects with both straight lines and ill-defined contours. Suitable for general photography.

### Type P

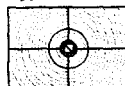

Same as Type K but with BriteView split-image range finder line at a 45° angle and etched horizontal and vertical lines as an aid to composition. Rapid and accurate focusing for subjects with horizontal or vertical lines or ill-defined contours. Suitable for general photography.

### Type G



Clear Fresnel field with extra-bright 12mm-dia. microprism focusing spot for viewing and focusing in poor light. Four models (G1, G2, G3, G4) available correspond to lenses with different focal lengths. Depth-of-field preview not available.

---

## POWER SOURCES

### **Nikon External Power Regulator MB-22**

The MB-22 consists of the grip portion MB-21G, in common with the MB-21, and the bottom portion MB-22B. The terminal enables connection with Nikon AC/DC Converter MA-4 via Nikon External Power Cord MC-11. A regulator, which converts the 15V current of the MA-4 to 8.2V, and a remote terminal are provided.

### **Nikon Multi-Power High-Speed Battery Pack MB-23**

The complete system consists of unitized battery pack/hand grip assembly and one-piece battery tray MS-23 for AA alkaline-manganese batteries or optional NiCd Battery Unit MN-20. A remote terminal and the terminal for MF-24 back are provided for the MB-23 as well as battery checker LEDs. Optional Quick Charger MH-20 can charge up to two MN-20 units sequentially, operate automatically with voltage from 100V to 240V.

### **Nikon AC/DC Converter MA-4 and External Power cord MC-11**

Especially recommended when using the F4 for extended studio use. Supplies constant 15V DC current to MB-22. The MC-11 Cord plugs into the external power terminal of the Nikon External Power Regulator MB-22.



MB-22



MB-23



MA-4 with MC-11

## OPTIONAL SPEEDLIGHTS

### Nikon Speedlight SB-24

The powerful SB-24 with built-in AF illuminator provides various balanced fill-flash capabilities. In addition, it offers more flexibility and performance with the F4.

- The zoom head automatically adjusts to provide an angle of coverage that matches the focal length of the lens in use.
- Flash output level can also be compensated on the SB-24.
- Repeating-flash mode lets you shoot a subject two or more times consecutively on the same frame. You can select number of flashes, frequency and either 1/8 or 1/16 light output.
- With rear-curtain sync flash, you can synchronize the flash with the instant the rear curtain starts moving. This turns available light into a stream of light that follows the flash-illuminated subject.
- All basic information is shown in the SB-24's own LCD.

### Nikon Speedlights SB-23/SB-22/SB-20

Each unit is equipped with an illuminator that enables autofocus even in total darkness. Various types of balanced fill-flash photography and other operations possible.

### TTL Remote Cord SC-24

Enables off-camera TTL auto flash operation with Nikon Speedlight SB-24, SB-23, SB-22, SB-21B, SB-20, SB-16B or SB-15 and an F4 with optional viewfinder DW-21 or DW-20. In addition, by using the SC-24 with Nikon TTL Remote Cord SC-23, you can use Nikon Speedlight SB-11, SB-14 or SB-140.

### TTL Remote Cord SC-17

For off-camera TTL flash with Nikon Speedlight SB-24, SB-23, SB-22, SB-21B, SB-20 or SB-16B and an F4 with viewfinder DP-20 or DA-20. The SC-17 also enables use of SB-23, SB-22, SB-21B, SB-20, SB-15, SB-11, SB-14 or SB-140 (with TTL Remote Cord SC-23) as a master flash unit. Two terminals are provided for TTL multiple flash photography.

### TTL Remote Cord SC-23

Enables off-camera TTL flash with Nikon Speedlight SB-11, SB-14 or SB-140 and an F4 with viewfinder DP-20 or DA-20.



F4s with SB-24



SC-24

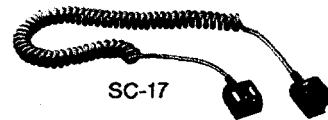

SC-17

## OPTIONAL CAMERA BACKS

### **Nikon Multi-Control Back MF-23**

The Multi-Control Back MF-23 enables the imprinting of any of the following data: date, time, frame number, serial upcount number, fixed number, shutter speed or aperture and exposure compensation value. Choice of imprint location — on the picture, or between frames. In addition, the MF-23 enables the camera to function in more advanced ways.

- Interval Timer — commencement time, interval time, number of shots taken and number of intervals can be input.
- Exposure Delay — remaining time before exposure and number of shots taken can be set.
- Long Time Exposure — you can choose any duration from one second up to 999 hours, 999 minutes and 999 seconds.
- Auto Bracketing — you can shoot up to 19 continuous frames, each with a different exposure.
- Freeze Focus — shutter is automatically released the moment the subject is in focus.
- Daily alarm, film alarm, film stop, and more.

Some of these functions work in combination, thus enlarging the F4's scope of applications.

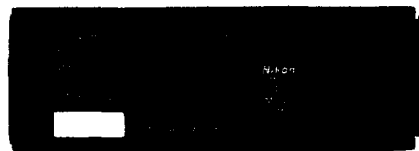

---

**Nikon Data Back MF-22**

A compact alternative to the MF-23. It will either imprint the data desired — year/month/day, day/hour/minute (24-hour clock), month/day/year or day/month/year — or leave the film blank, with no imprint.

**Nikon 250-Exp. Multi-Control Back MF-24**

Especially recommended for sports or scientific/industrial applications. The MF-24 allows uninterrupted shooting of up to 250 exposures without changing film. Used with two Nikon 250-Exposure MZ-1 Magazines for loading up to 10m of bulk film. Power sources for the MF-24 are Nikon High Speed Battery Pack MB-21 or External Power Regulator MB-22.

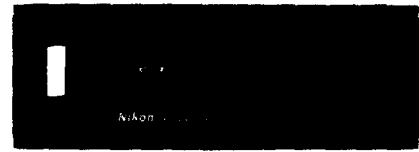

MF-22

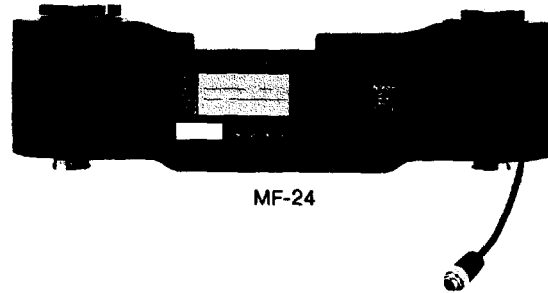

MF-24

## VIEWING ACCESSORIES

The F4's standard, supplied Multi-Meter Finder DP-20 accepts the following accessories.

### **Nikon Eyepiece Correction Lenses**

Five lenses for Nikon F3HP — -3, -2, 0, +1 and +2 diopters — are available. When used with diopter adjustment dial of the Multi-Meter Finder DP-20 the combined adjustment range will be from -5 to +4 diopters.

### **Nikon Rubber Eyecup DK-2**

The eyecup prevents stray light from entering the viewfinder from the rear and allows eyeglass wearers to use the F4 without fear of scratching their glasses.

### **Nikon Right-Angle Viewing Attachment DR-3**

Excellent for copy work, the DR-3 provides an upright, unreversed image for right-angle viewing with the DK-7. Individual eyesight adjustments are possible.



Eyepiece Correction Lenses



DK-2



DR-3



---

**Nikon Eyepiece Magnifier DG-2**

Provides 2x magnification of the central portion of the finder image with Eyepiece Adapter DK-1. Eyesight adjustment provided. Useful for critical focusing in close-up photography.

**Nikon Eyepiece Adapter DK-7**

Lets you attach the DR-3 or DG-2 to the Multi-Meter Finder DP-20's eyepiece.



DG-2



DK-7

---

## CLOSE-UP ACCESSORIES

### **Nikon Auto Extension Rings**

Compact and lightweight, Nikon Auto Extension Rings slide on and off your camera in seconds for a wide range of reproduction ratios. Models include the PK-11A, 12 and 13. Because information on lens aperture is relayed via the PK ring to the camera, the exposure is determined by TTL full aperture metering. Exposure modes usable: Aperture-Priority (A) Auto Exposure or Manual (M).



Auto Extension Rings

### **Nikon Bellows Attachment PB-6**

Mounts between the F4 and the lens for close-up and macro photography. At the twist of a knob, you can vary lens extension at will, producing reproduction ratios from 1 : 1.1 up to 4 : 1 with a 50mm lens mounted normally. The lens can also be mounted in reverse to maintain aberration correction in the extreme close-up range. The PB-6 has a stop-down lever so you can use stop-down metering. Exposure modes usable: Aperture-Priority (A) Auto Exposure and Manual (M).

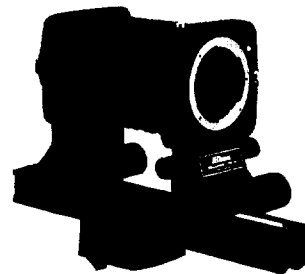

PB-6

---

**Nikon Repro-Copy Outfit PF-4**

Enables you to make high-quality photographic copies of photographs, illustrations, drawings or diagrams.

\*With Nikon High Speed Battery Pack MB-21, use of Nikon Camera Holder Adapter PA-4 is required.

**Nikon Macro Adapter Ring BR-2A**

Fits between the camera and lens to enable lenses to be mounted in reverse; an inexpensive means of obtaining a relatively high reproduction ratio. The BR-2A also increases the working distance for normal or wideangle lenses.

**Nikon Focusing Stage PG-2**

Simplifies close-up focusing when using a tripod-mounted F4.

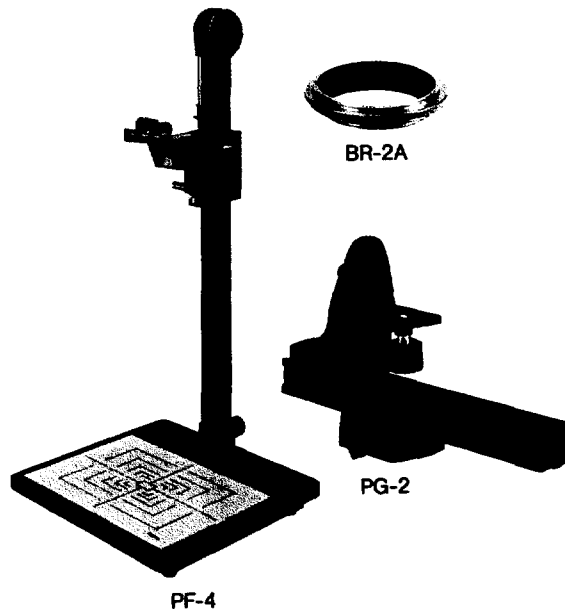

## REMOTE CONTROL ACCESSORIES

The following accessories can be used with Nikon High Speed Battery Pack MB-21 or External Power Regulator MB-22.

### **Nikon Remote Cord with Button Release MC-12A**

For remote control photography up to 3m (9.8 ft) away, the MC-12A has a handgrip, trigger release button and trigger lock lever that make operation convenient. Depressing the MC-12A halfway turns on the camera's exposure meter; depressing fully releases the shutter. Trigger lock lever provided also enables time exposure with ease.

### **Nikon Remote Cord MC-4A**

The plug on one end of the MC-4A connects to the MB-21 or MB-22's remote-control socket; the other end has both plus and minus banana-type plugs. Used to fire several cameras simultaneously.

### **Nikon Radio Control Set MW-2**

Provides interference-free remote control up to 700m (2295 ft). Three separate channels allow three cameras to be operated automatically. Easy to handle.

### **Nikon Modulite Remote Control Set ML-2**

Provides infrared light remote control for three separate channels to enable automatic operation of motor-driven cameras at distances up to 100 meters. Compact and easy to handle. Wireless multiple flash operation is also possible.



MC-12A



MC-4A

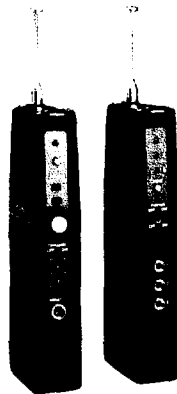

MW-2

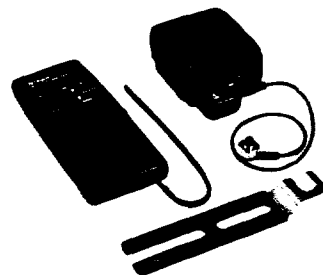

ML-2

### **Nikon Intervalometer MT-2**

For unmanned time-lapse photography or work sampling. Quartz-controlled MT-2 provides either 2 sec. or 16 sec. delay shutter release, allowing time for focusing or flash recycling. It can also be used with other remote-control devices.

### **Nikon Cable Release AR-3 and Double Cable Release AR-7**

Essential for slow shutter speeds, these cable releases ensure one-hand, shutter release operation. The AR-3 and AR-7 plug into the release terminal of the camera body.

### **Nikon Pistol Grip Model 2 and Connecting Cord MC-3A**

Nikon's special pistol grip can be screwed into either the camera's tripod socket or the tripod mounting collar of a super-telephoto lens to provide more stable handheld shooting. The MC-3A Cord plugs into the remote terminal of Nikon High Speed Battery Pack MB-21 or Nikon External Power Regulator MB-22.

### **Nikon Connecting Cords MC-17 and MC-17S**

Either the MC-17 or MC-17S can be used to fire two cameras almost simultaneously. The MC-17 is approx. 3m (9.8 ft) long; the MC-17S, approx. 0.4m (1.3 ft). The 250-Exp. Multi-Control Back MF-24 must be attached to the master camera.



MT-2

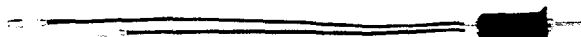

AR-7



AR-3

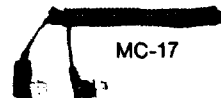

MC-17

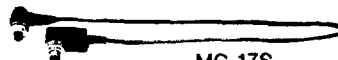

MC-17S



Pistol Grip Model 2  
with MC-3A

## CAMERA CARE TIPS

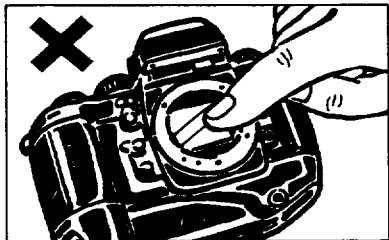

1. Avoid touching the reflex mirror or focusing screen. Remove dust with a blower brush.

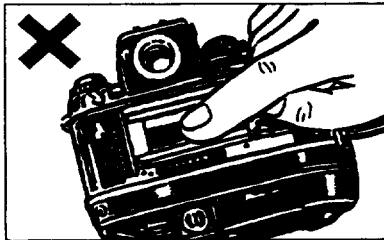

2. Do not touch the shutter curtains.

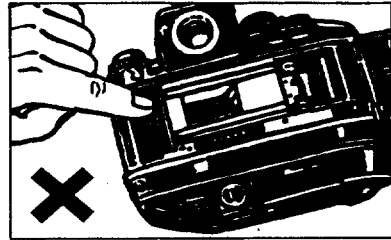

3. Do not touch the DX contacts. Keep clean with blower brush.



7. Clean the viewfinder eyepiece with a soft, clean cloth. Do not use alcohol.

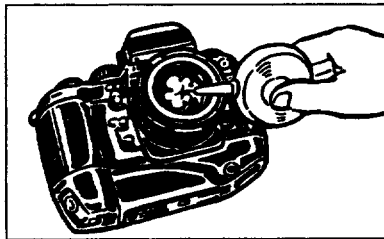

8. Clean glass surfaces such as the lens with a blower brush; avoid using lens tissue as much as possible. To remove dirt and smudges, use soft cotton moistened with pure alcohol and wipe

in a spiral motion from center to periphery. Be careful not to leave traces.

### Caution

Spray gun-type blowers may damage the glass if used to clean the lens, especially when ED glass is used for the front lens element. To avoid damage, hold the blower upright with its nozzle more than 30cm (12 in.) from the lens surface and keep the nozzle moving so the stream of air is not concentrated in one spot.



4. Avoid leaving the camera in an excessively hot place.



5. Keep the camera away from water or excessive moisture. When using the camera near water, guard against splashes, especially saltwater spray.



6. If the camera malfunctions, remove batteries and take it immediately to an authorized Nikon dealer or service center.

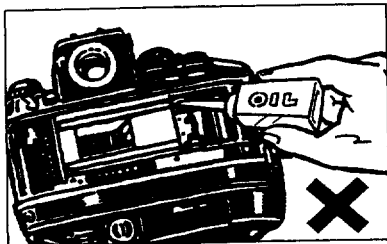

9. Do not lubricate the camera.

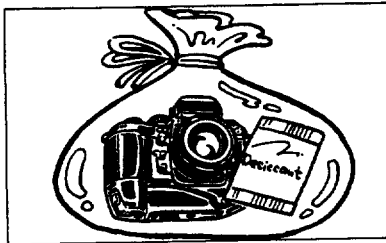

10. Store the camera in a cool, dry place away from naphthalene or camphor (moth repellents). In a humid environment, store the camera with a desiccant inside a vinyl bag to keep out dust, moisture and salt.

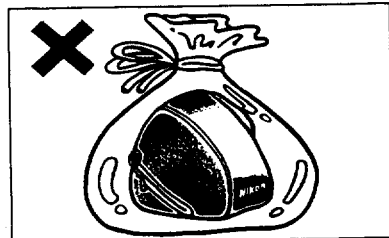

Note, however, that storing leather goods in a vinyl bag may cause the leather to deteriorate.

## NOTES ON BATTERIES

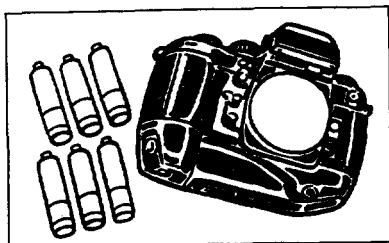

1. When not using the camera for a long period, remove batteries.

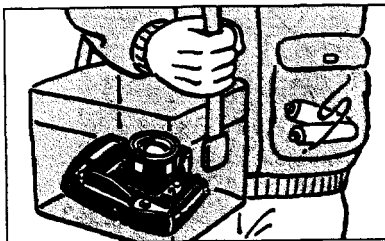

2. Battery power falls off in extremely low temperatures; when shooting in such an environment, make sure the batteries you use are fresh, and wrap the camera body in something warm.

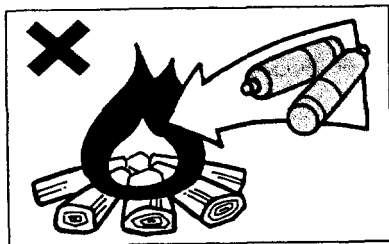

6. Do not throw used batteries into a fire.

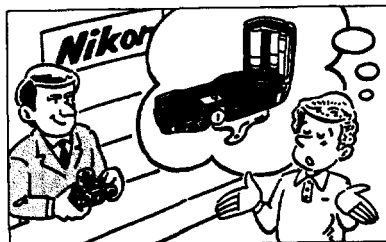

7. If the battery chamber is contaminated by battery leakage, take the camera to an authorized Nikon dealer.



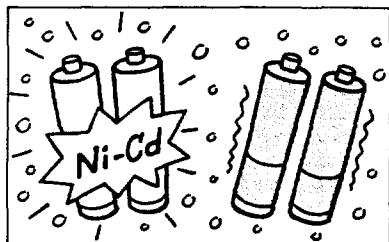

- 3.** Compared with regular batteries, NiCd batteries provide greater efficiency at low temperatures. Before charging NiCd batteries, thoroughly read the instructions for batteries and battery charger.

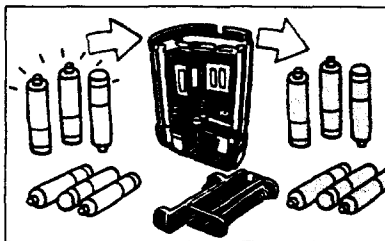

- 4.** When replacing batteries, be sure to replace all batteries at the same time. Always use fresh batteries of the same brand.

Batteries with a "+" terminal exceeding 6mm in diameter cannot be used.

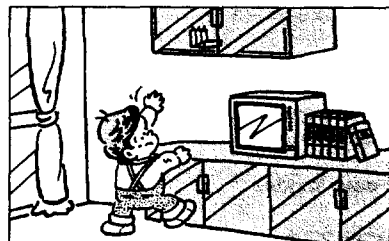

- 5.** Keep batteries out of children's reach.

## SPECIFICATIONS

<b>Type of camera</b>	Integral-motor 35mm single-lens reflex	<b>Exposure metering</b>	Matrix Metering (with Multi-Meter Finder DP-20); Center-Weighted Metering (with Multi-Meter Finder DP-20 or AE Action Finder DA-20); Spot Metering (with any finder)
<b>Picture format</b>	24mm x 36mm (standard 35mm film format)	<b>Exposure meter switch</b>	Activated by lightly pressing shutter release button; stays on for approx. 16 sec. after lifting finger from button
<b>Lens mount</b>	Nikon F mount	<b>Metering range</b>	EV 0 to EV 21 at ISO 100 with f/1.4 lens; EV 2 to EV 21 with Spot Metering
<b>Lenses usable</b>	AF Nikkor lenses, and Nikon F-mount lenses	<b>Exposure control</b>	Manual (M), and Programmed (P, P), Shutter-Priority (S) and Aperture-Priority (A) Auto Exposure
<b>Focus modes</b>	Manual focus with electronic rangefinder and Autofocus	<b>Auto exposure lock</b>	Available by pressing AE-L button while meter is on
<b>Autofocus</b>		<b>Exposure compensation</b>	Possible using exposure compensation dial within $\pm 2$ EV range in 1/3 EV steps
<b>Autofocus detection system</b>	TTL phase detection system using Nikon advanced AM200 autofocus module	<b>Multiple exposure</b>	Via lever
<b>Autofocus detection range</b>	Approx. EV minus 1 to EV 18 at ISO 100 (under Nikon inspection conditions)	<b>Depth-of-field preview button</b>	Provides visual verification of depth of field; can be previewed in M or A mode; coaxial with mirror lockup lever
<b>Autofocus actuation method</b>	Single Servo or Continuous Servo	<b>Reflex mirror</b>	Automatic instant-return type with lockup facility
<b>Autofocus lock</b>	Possible by lightly pressing shutter release button in Single Servo AF mode or by using AF-L button; simultaneous use with AE-L button possible	<b>Shutter</b>	Electromagnetically controlled vertical-travel focal-plane shutter; shutter balancer incorporated
<b>Electronic rangefinder</b>	Available in Manual focus mode with AF Nikkor lenses, AI-type Nikkor lenses including AI-modified Nikkor lenses and non-AI-type Nikkor lenses with a maximum aperture of f/5.6 or faster	<b>Shutter release</b>	Electromagnetic shutter by magnet trigger

**Shutter speeds**

Lithium niobate oscillator-controlled; controlled from 1/8000 to 30 sec. steplessly in P<sub>H</sub>, P or A mode; set from 1/8000 to 4 sec. in one EV steps in M or S mode; B, T and X (1/250 sec.)

**Viewfinder**

Nikon Multi-Meter Finder DP-20 provided as standard; fixed eyelevel pentaprism high-eyepoint type; 0.7X magnification with 50mm lens set at infinity; approx. 100% frame coverage; metering system selector, diopter adjustment knob, accessory shoe, compensation dial for focusing screens and eyepiece shutter lever provided; interchangeable with Nikon AE Action Finder DA-20, Nikon 6X High-Magnification Finder DW-21 and Nikon Waist-Level Finder DW-20

**Viewfinder information**

By LCD – exposure compensation value, frame counter (additive type), metering system in use, shutter speed, aperture, exposure mode, electronic analog display, AE-Lock indicator; by ADR window – lens aperture; by LED display – focus indicators, exposure compensation mark and flash ready-light. Illuminator switch provided for dim-light viewing

**Eyepoint****Focusing screen**

Approx. 22mm

Nikon advanced B-type BriteView screen with central focus brackets for autofocus operation; interchangeable with 12 optional screens

**Film speed range**

ISO 25 to 5000 for DX-coded film; ISO 6 to 6400 in 1/3 EV steps for manual setting

**Film speed setting**

At DX position, automatically set to ISO speed of DX-coded film used; manual override possible

**Film loading**

Film automatically advances to first frame when shutter release button is depressed once

**Film advance**

In S (single frame) shooting mode, film automatically advances one frame when shutter is released; in C<sub>H</sub> (Continuous high speed), C<sub>L</sub> (Continuous low speed) or C<sub>S</sub> (Continuous silent) shooting mode, shots are taken as long as shutter release button is depressed; shooting speed is approx. 5.7 fps (C<sub>H</sub>), 3.4 fps (C<sub>L</sub>) or 1.0 fps (C<sub>S</sub>) – For Continuous Servo Autofocus, with AF Zoom-Nikkor 35-70mm f/3.3-4.5 lens, new six AA-type alkaline-manganese batteries, a shutter speed of 1/250 sec. or faster, at normal temperature.

**Frame counter** Two additive types provided — on top of camera and inside viewfinder (LCD)

**Film rewind** Choice of automatic or manual; automatically rewinds when film rewind levers (R1) and (R2) are used; takes approx. 8 sec. per 36-exposure roll (with six AA-type batteries); stops automatically when film is rewound; manual rewind when R1 lever is used

**Self-timer** Electronically controlled 10 sec. exposure delay; blinking LED indicates self-timer operation; cancelable

**Camera back** Hinged back; interchangeable with Nikon Multi-Control Back MF-23 or Data Back MF-22

**Accessory shoe** Standard ISO-type hot-shoe contact; ready-light contact, TTL flash contact, monitor contact

**Flash synchronization** 1/60 to 1/250 sec. in P<sub>H</sub>, P or A mode; in M or S mode, shutter fires at speed set, and when set from 1/250 to 1/8000 sec., shutter is automatically set to 1/250 sec.; down to 30 sec. shutter is available by using SB-24 in rear-curtain sync in P<sub>H</sub>, P or A mode

**Flash ready-light** Viewfinder LED lights up when Nikon dedicated speedlight is ready to fire; blinks to warn of poor camera/speedlight connection or insufficient light for correct exposure

**Autofocus flash photography** Possible with Nikon Autofocus Speedlights SB-24, SB-23, SB-22 or SB-20

**Power source** Nikon High Speed Battery Pack MB-21 (six AA-type alkaline-manganese or NiCd batteries), Battery Pack MB-20 (four AA-type alkaline-manganese batteries), External Power Regulator MB-22

**Number of 36-exposure film rolls per set of fresh batteries**

Batteries		At 20°C (68°F)	At -10°F (14°F)
High Speed Battery Pack MB-21	Alkaline-manganese (LR6)	approx. 90	approx. 15
	NiCd batteries (NiCd)	approx. 70	approx. 35
Battery Pack MB-20	Alkaline-manganese (LR6)	approx. 30	approx. 5

\*For Continuous Servo Autofocus with AF Zoom-Nikkor 35-70mm f/3.3-1/4.5 lens, film advance mode selector at CH and a shutter speed of 1/250 sec. or faster.

**Checking battery power**

Battery power is sufficient if viewfinder LCD appears when shutter release button is lightly pressed; LCD remains on for approx. 16 sec. after finger is removed from button; battery power insufficient if LCD turns off immediately after finger is removed from shutter release button; if no data appears and shutter does not operate, batteries are exhausted or improperly loaded

**Dimensions (WxHxD)**

With High Speed Battery Pack  
MB-21: 169 x 139 x 77mm  
(6.7 x 5.5 x 3.0 in.), with Battery Pack  
MB-20: 169 x 118 x 77mm  
(6.7 x 4.6 x 3.0 in.)

**Weight (body only)**

With High Speed Battery Pack  
MB-21: approx. 1280g (45.1 oz.), with  
Battery Pack MB-20: approx. 1090g  
(38.4 oz.)

Specifications and designs are subject to change without notice.

This device complies with Part 15 of the FCC Rules. Operation is subject to the following two conditions: (1) This device may not cause harmful interference, and (2) this device must accept any interference received, including interference that may cause undesired operation.

This equipment has been tested and found to comply with the limits for a Class B digital device in accordance with the specifications set forth in Part 15 of the FCC Rules. If this equipment does cause interference to radio or television reception which can be determined by turning the equipment on and off, use the equipment in another location and/or utilize an electrical outlet different from that used by the receiver.

"This digital apparatus does not exceed the (Class B) limits for radio noise emissions from digital apparatus set out in the Radio Interference Regulations of the Canadian Department of Communications."

For multiple flash photography using Nikon Speedlights, if the electric current in the sync circuit exceeds a certain level, you may not be able to take a second picture after taking the first. Take care that the combined total of the coefficients (numbers shown in parentheses below) for all of the speedlights used at any one time does not exceed 20 at 20°C/68°F (13 at 40°C/104°F).

SB-24 (1)	SB-23 (4)	SB-22 (6)	SB-21 (4)
SB-20 (9)	SB-19 (2)	SB-18 (16)	SB-17 (4)
SB-16 (4)	SB-15 (4)	SB-14 (1)	SB-12 (1)
SB-11 (1)			

If you are unable to take a second picture, disconnect master speedlight from the F4, or turn each of the speedlights off and on once.

In certain cases, due to static electricity or poorly loaded batteries, the F4's microcomputer may turn the camera off, even with fresh, properly installed batteries. For the same reason, film may not advance properly. In each of these cases, to resume operation, simply turn the power OFF and turn ON again, or remove batteries and install again.

The Nikon autofocus SLR system is designed based on the premise that any of its components, such as the F4, F-801/N8008\*, F-501/N2020\*\*, F-401s/N4004s\*\*, AF Nikkor lenses, TC-16A Autofocus Converter, Nikon speedlights and Nikon accessories will be used integrally, with one another.

AF Nikkor lenses electronically communicate all the necessary information required for perfect operation within current and future Nikon autofocus SLR systems. Nikon does not assume responsibility if malfunctions or damage occurs to the F4 when lenses and/or accessories of other makers are used with it. For these reasons, we recommend the use of AF Nikkor lenses and Nikon system accessories.

\* Exclusively sold in U.S.A.

\*\* Exclusively sold in U.S.A. and Canada

Nikon cannot be held responsible for any malfunction resulting from the use of the camera other than as specified in this manual.

The shutter cannot be released while camera back is open. If for some reason you need to release the shutter with the camera back open, consult a Nikon service facility. Also, be sure to set the shutter speed to 1/250 sec. or higher; do not set to 1/125 sec. or slower.

---

No reproduction in any form of this manual, in whole or in part (except for brief quotation in critical articles or reviews), may be made without written authorization from NIKON CORPORATION.

The Nikon logo is centered horizontally and consists of the word "Nikon" in a bold, italicized, sans-serif font. The text is white and is set against a thick, solid black horizontal bar that spans most of the width of the page.

***Nikon***

**NIKON CORPORATION**

FUJI BLDG., 2-3, MARUNOUCHI 3-CHOME, CHIYODA-KU, TOKYO 100, JAPAN  
**PHONE:** 81-3-3214-5311 **TELEX:** NIKON J22601 **FAX:** 81-3-3201-5856

---

Printed in Japan 9&212-Ge10 (S520)