

# PENTAX®

# SF7



Welcome to the fantastic world of Pentax autofocus SLR photography!

This camera is a high-precision 35mm SLR camera incorporating such advanced technological features as auto focusing, auto exposure, auto film winding/rewinding and a built-in Retractable TTL-Auto Flash (RTF). Please read this operating manual carefully for a full explanation of the camera's functions and operations before you start using it.

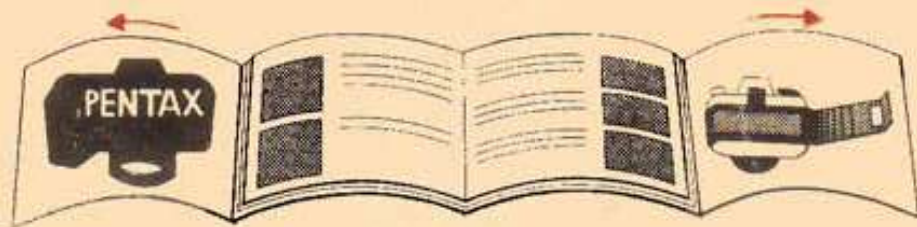

The names of the camera's working parts are listed in the nomenclature sections on the front and back flaps of this manual, so please keep the flaps unfolded for quick reference while you read this manual.

We sincerely hope you will enjoy taking memorable, high-quality pictures with this remarkable camera for many years to come.

Commercially available lenses and accessories produced by other manufacturers are not made to our precise specifications and therefore, may cause difficulties with – or actual damage to – your Pentax camera. We do not assume any responsibility or liability for difficulties resulting from the use of lenses and accessories made by other manufacturers.



# NOMENCLATURE

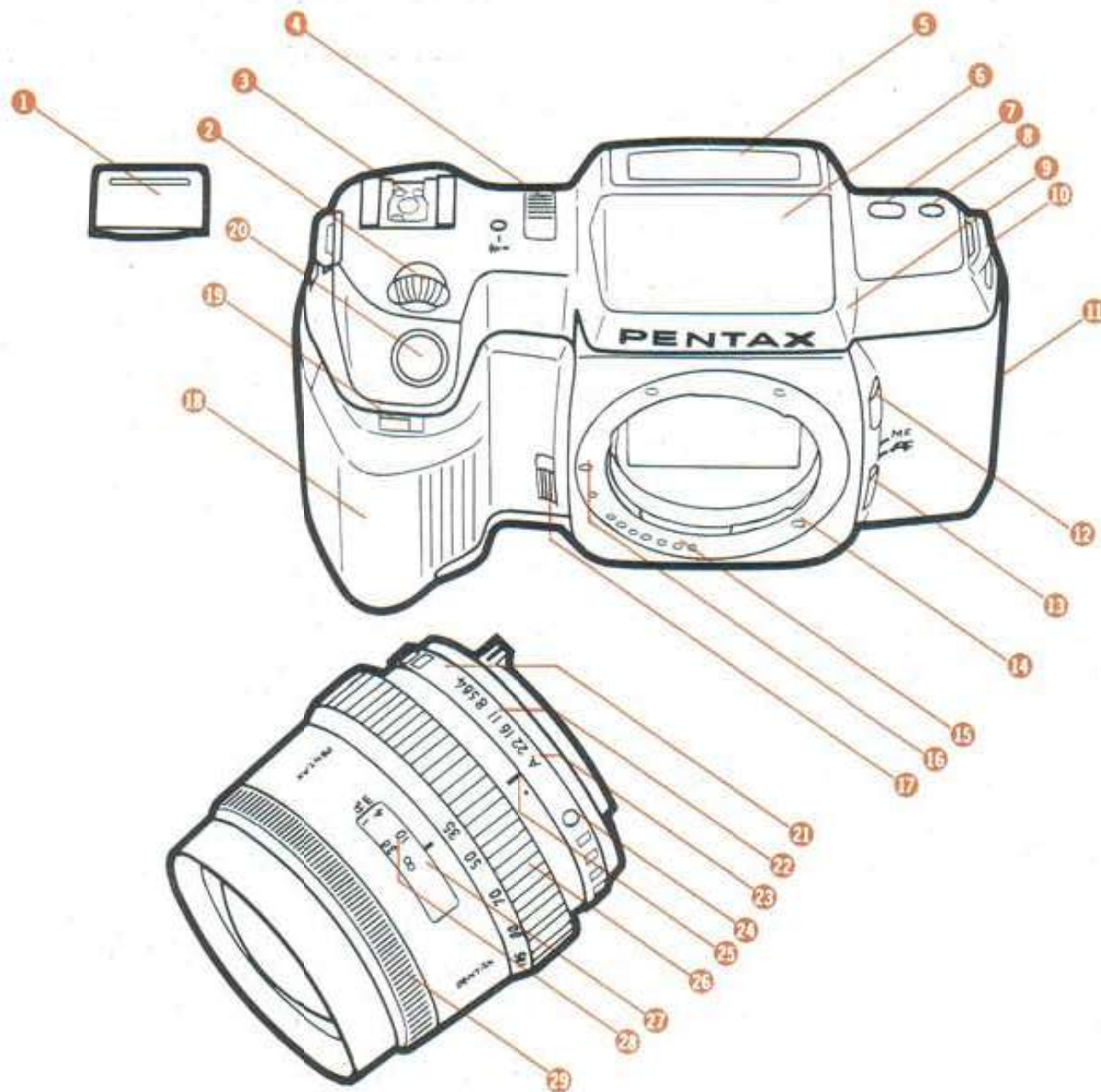

- 1 Hot-shoe cover
- 2 Select dial
- 3 Hot shoe
- 4 Main switch
- 5 LCD panel
- 6 Built-in flash (RTF)
- 7 Mode button
- 8 Drive/Self-timer button
- 9 Flash-pop-up switch
- 10 Strap lug
- 11 Back-cover-release lever
- 12 Release socket F
- 13 Focus-mode switch
- 14 AF coupler
- 15 Lens-information contacts
- 16 Mount index
- 17 Lens-lock-release lever
- 18 Grip
- 19 Self-timer lamp
- 20 Shutter-release button
- 21 Aperture ring
- 22 Aperture scale
- 23 Aperture-A index
- 24 Aperture-A-lock button
- 25 Distance/Aperture index
- 26 Zoom ring
- 27 Distance-scale window
- 28 Distance scale
- 29 Focusing ring



2000

Indicates a manually-selected shutter speed. "2000" means 1/2000 second and "1" means one second.



Warns that the battery level is running low.

36

Indicates an exposure frame number from "1" to "36".



Tells you to use the select dial.

AUTO

Indicates the lens aperture ring is set at [A] (auto).



Indicates the aperture ring is set at an f-number other than [A].



Indicates the condition of RTF.

PROG.

Indicates the Programmed AE mode is selected.

AUTO

Indicates the Aperture-Priority AE mode is selected.



Indicates the condition of the film.

AF

Indicates the auto-focus mode is selected.

MF

Indicates the manual-focus mode is selected.



Indicates the self-timer mode is selected.



Indicates the consecutive film-advance mode is selected.



Indicates the single film-advance mode is selected.

## TABLE OF CONTENTS

---

- Nomenclature ..... Covers
- LCD indication/Viewfinder indication ..... Covers

### PRESHOOTING PREPARATIONS

1. Fastening camera strap ..... 3
2. Positioning battery ..... 4
3. Mounting lens ..... 6
4. Loading film ..... 8
5. Soft case ..... 11

### BASIC OPERATION

1. Operating main switch ..... 13
2. Operating shutter-release button ..... 13
3. Selecting Programmed AE mode ..... 14
4. Selecting single film advance mode ..... 16
5. Selecting focus mode ..... 16
6. Holding camera & preventing camera shake ..... 17
7. Focusing ..... 18
8. Using focus-lock function ..... 20
9. Using zoom lens ..... 21
10. Taking a picture ..... 22
11. Shooting with built-in RTF ..... 24
12. Using AF spotbeam projector ..... 29
13. Rewinding film ..... 30

### OPERATION OF MAJOR FUNCTIONS

- Exposure modes using F-series lenses ..... 33
- Using Shutter-Priority AE mode ..... 36
- Using Aperture-Priority AE mode ..... 38
- Using Metered Manual mode ..... 40
- Difficult subjects for auto focusing ..... 42
- Manual focusing ..... 43
- Using exposure memory lock function ..... 44
- Using self-timer ..... 45

### OTHER FUNCTIONS

- Focusing in matte area ..... 47
- Using Pentax dedicated flash units ..... 48
- TTL Auto Flash and Programmed Auto Flash modes .. 50
- Using Bulb mode ..... 52
- Infrared index ..... 53
- Eyecup FB ..... 53
- Viewfinder warnings ..... 54
- Depth of field ..... 56
- Functions using conventional Pentax lenses ..... 58
- Precautions on battery ..... 59
- Taking care of your camera ..... 60
- Specifications ..... 62
- Warranty policy ..... 64

# PRESHOOTING PREPARATION

1. Fastening camera strap .....	3
2. Positioning battery .....	4
3. Mounting lens .....	6
4. Loading film .....	8
5. Soft case .....	11

## 1. FASTENING CAMERA STRAP

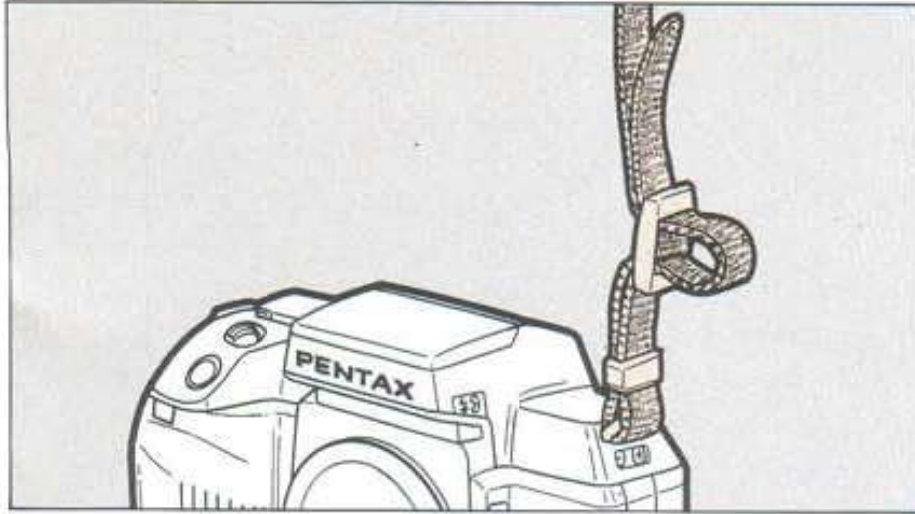

Fasten the camera strap as illustrated. It is recommended to adjust the length of the strap so that the camera is positioned above your waist to prevent the camera from swinging while you walk.

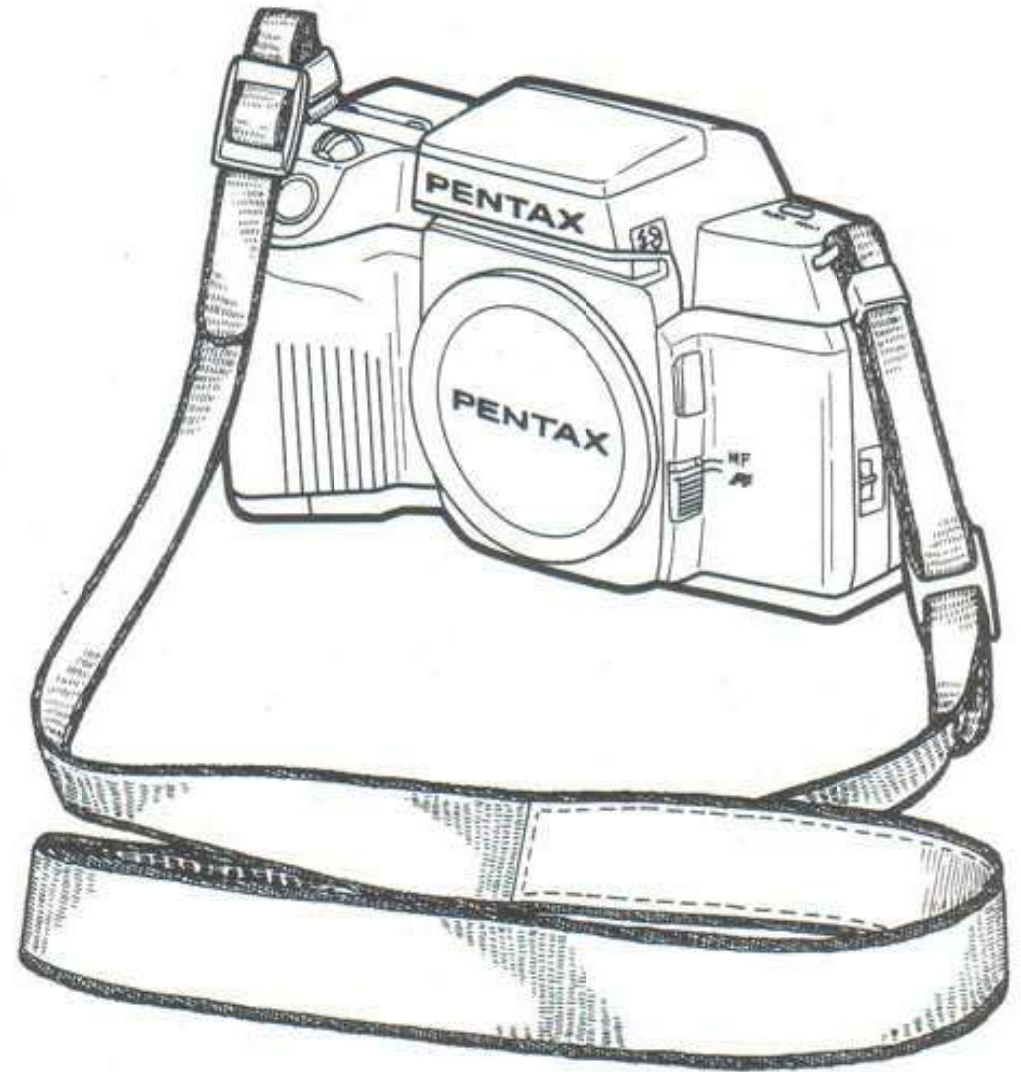

## 2. POSITIONING BATTERY

1

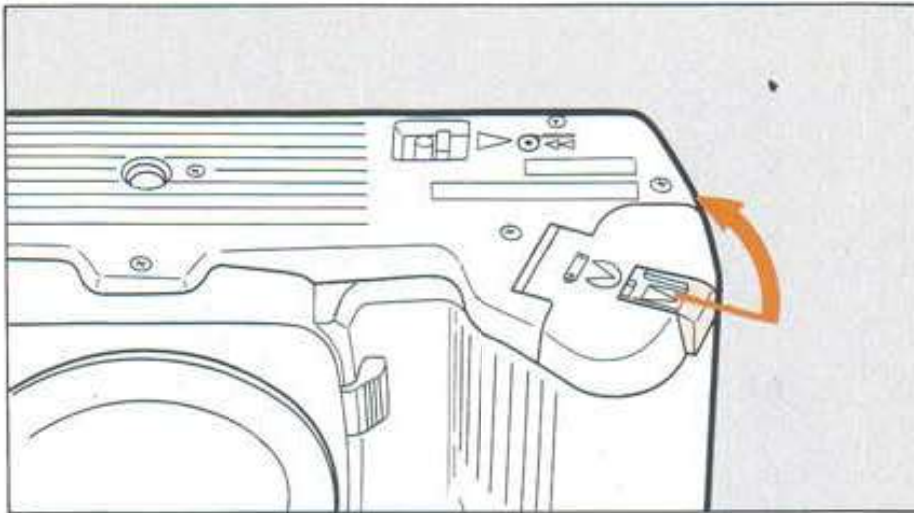

1. Pull the battery chamber cover release lever in the direction indicated by [ ► ] to open the battery chamber cover.

2

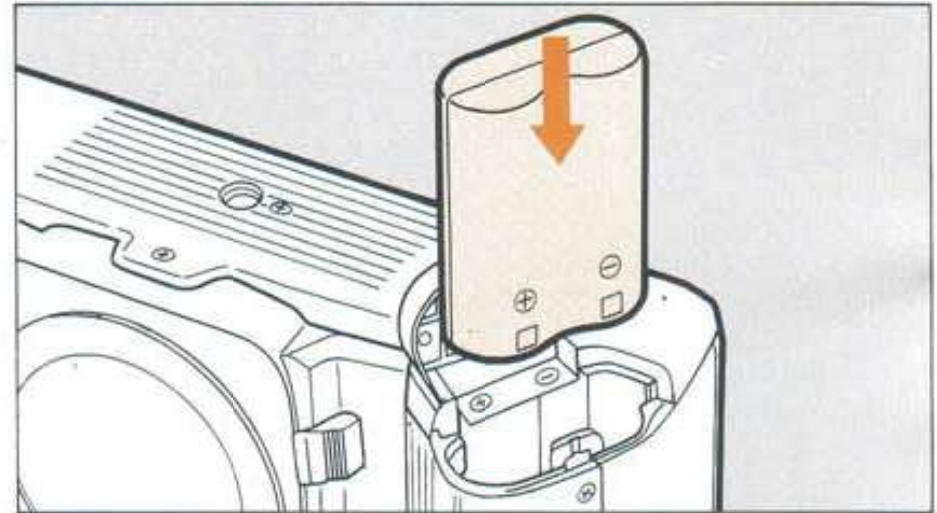



2. Position the battery with its metal contact facing down, then close the back cover by reversing step 1.

**Note:** This camera operates on a battery, so be sure to insert one "2CR5" lithium battery as designated before you start operating it.



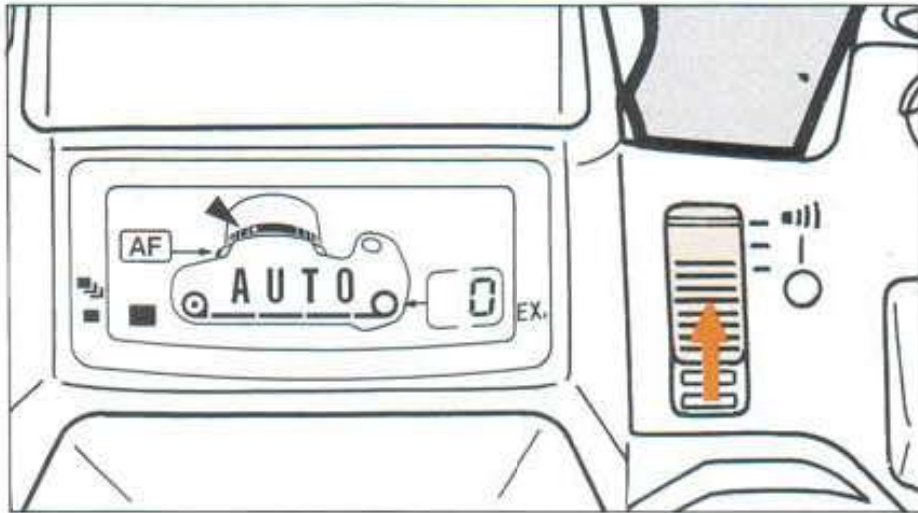

3

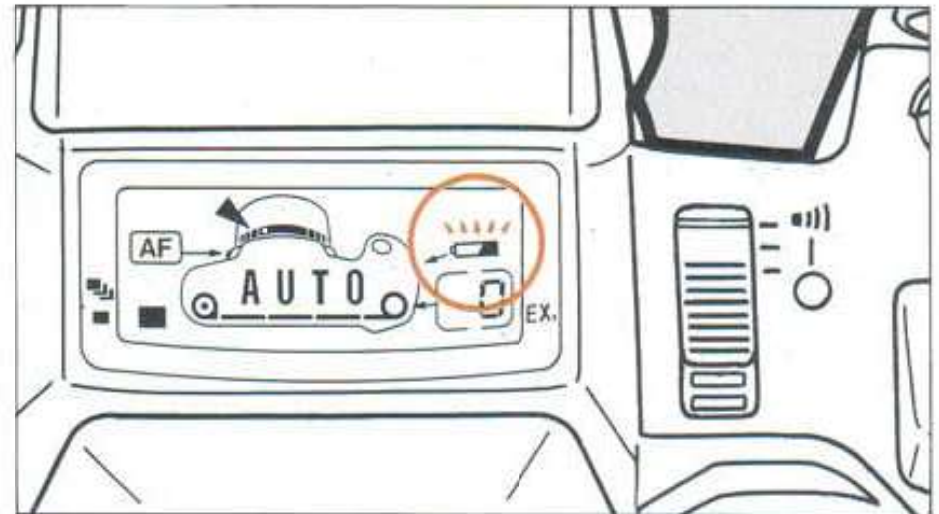

3. Set the main switch to [  ] and confirm that the auto-exposure mark [ **AUTO** ] appears in the LCD panel.



**Note: Warning for low battery level**

When the battery level becomes low, the low battery warning [  ] comes on, and the battery should be changed as soon as possible. The shutter will lock up shortly after the [  ] starts blinking.

**Note:** Even if the battery is inserted upside-down, the indications appear in the LCD panel, but the shutter cannot be released.

### 3. MOUNTING LENS

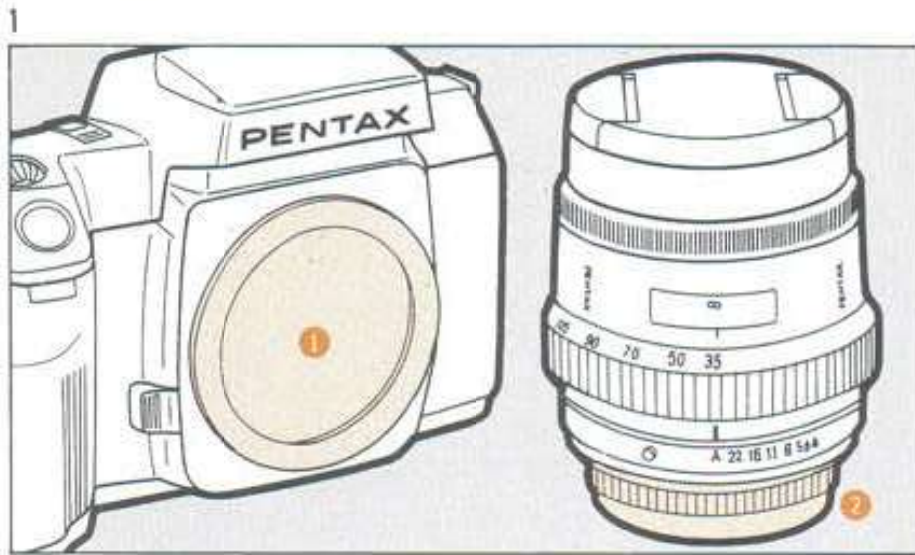

1. Remove the body-mount cap ❶ and the rear lens cap ❷

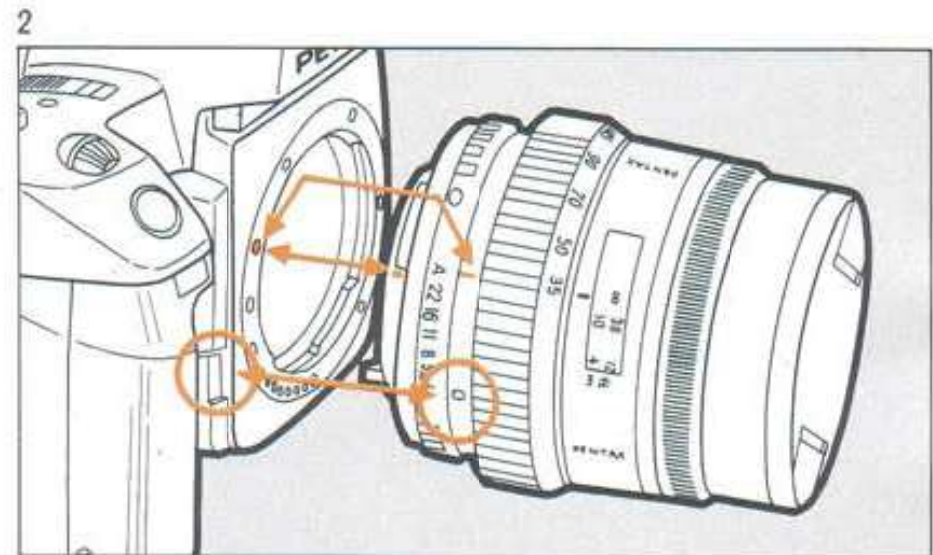

2. Align the red mount indexes of the camera and the lens, place the lens onto the camera's lens mount, then turn the lens clockwise until it locks with a click.

- The body-mount cap is designed to protect the camera from scratches and dust when it is shipped from the factory. For storing purposes, use the optional Body Mount Cap K.

3

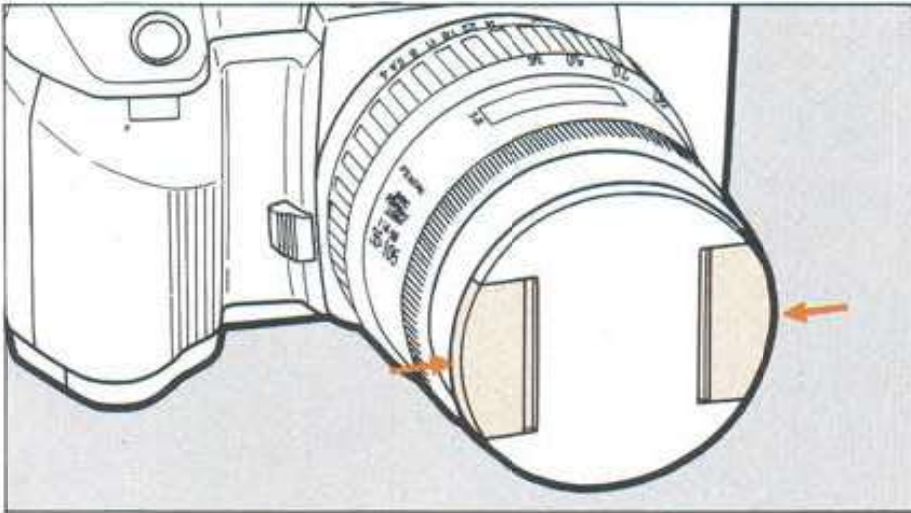

3. Remove the front lens cap by pressing in the tabs on both sides.

※

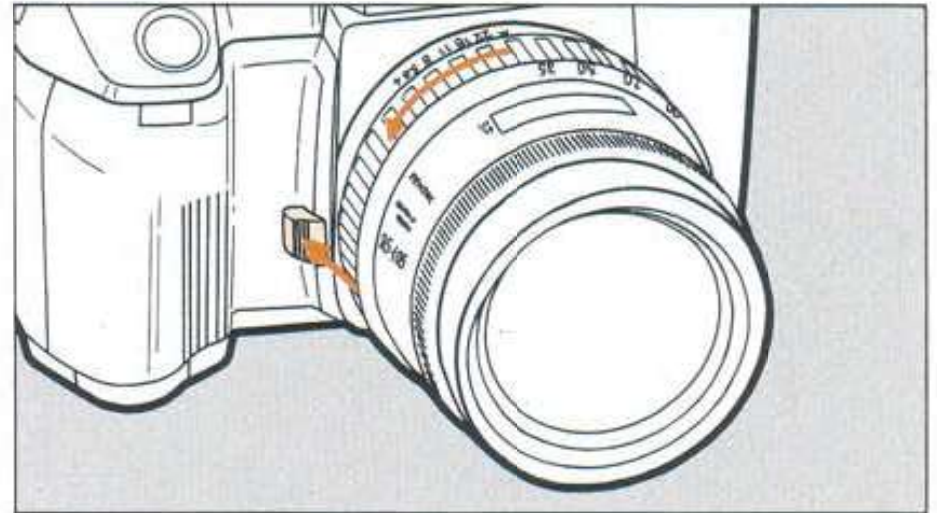

- ※ To disengage the lens, turn the lens counterclockwise while depressing the lens-lock release lever.

**Note:**

Do not damage or stain the lens information contacts or the AF coupler on the mount surfaces of the camera and the lens. If this occurs, wipe them gently with a clean dry cloth.

## 4. LOADING FILM

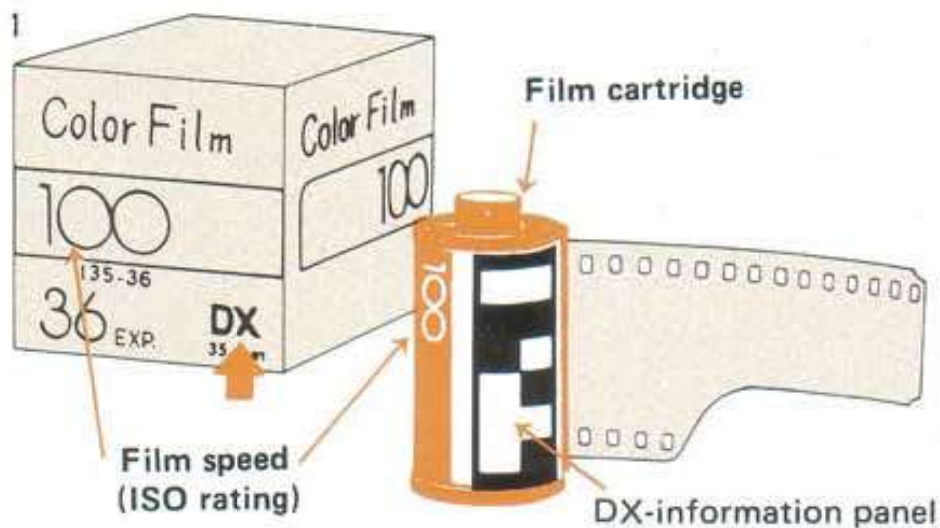

1. Use DX-coded film with an ISO speed between 25 and 5000.

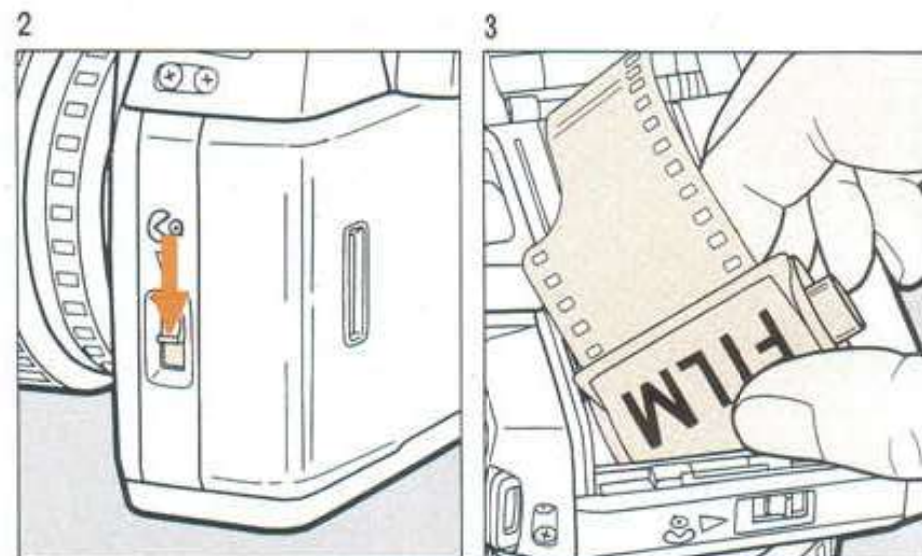

2. Push down the back-cover release lever to open the back cover.
3. Hold the film cartridge with its protruding side down and slide the upper end in first.

- The camera automatically sets the ISO film speed for DX-coded film.
- Non-DX-coded film is automatically set at ISO 100.

4

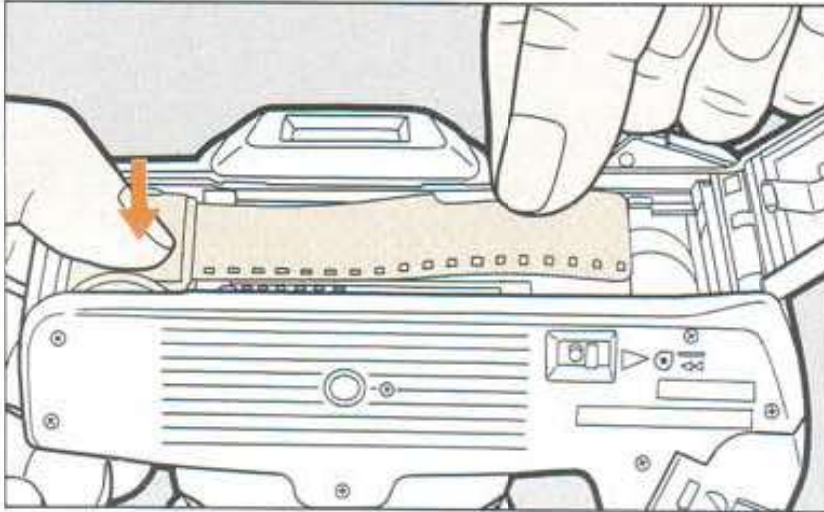

4. While holding the cartridge with your left hand, pull the film leader out.

5

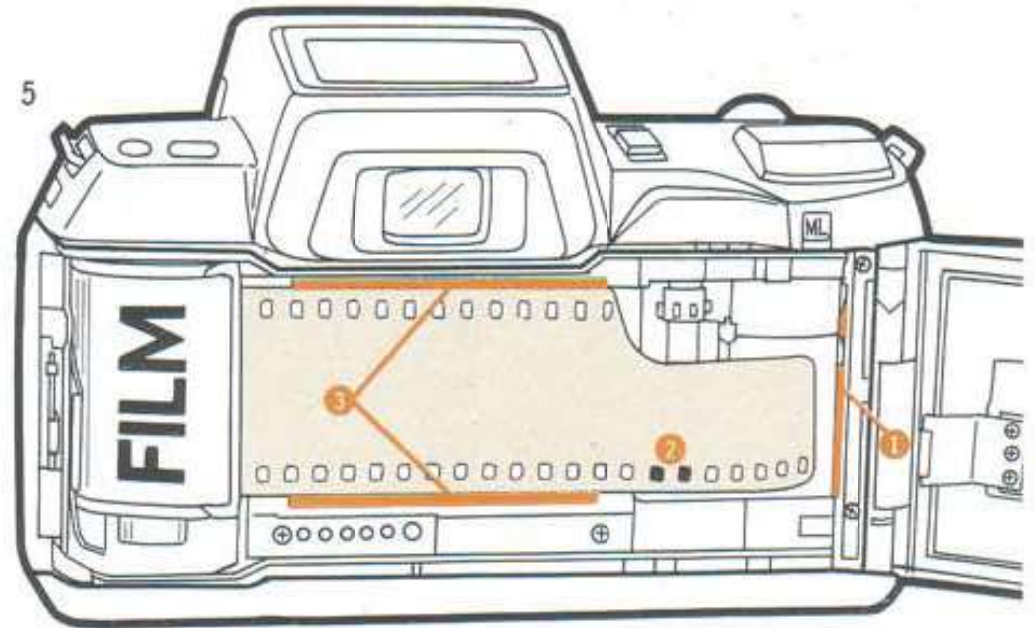

5. Position the film leader end at the film loading mark ①, as illustrated. Make sure the film perforations engage the sprocket teeth ② properly. Also make sure the film is placed properly between the film guide rails ③.

**Note:**

- The shutter curtains are made of a thin, delicate material to maintain extreme precision. Be careful not to touch them with your hand or the film end during film loading.
- The DX-information pins are contacts to read the film's ISO speed, so keep them free of dirt, dust and scratches.

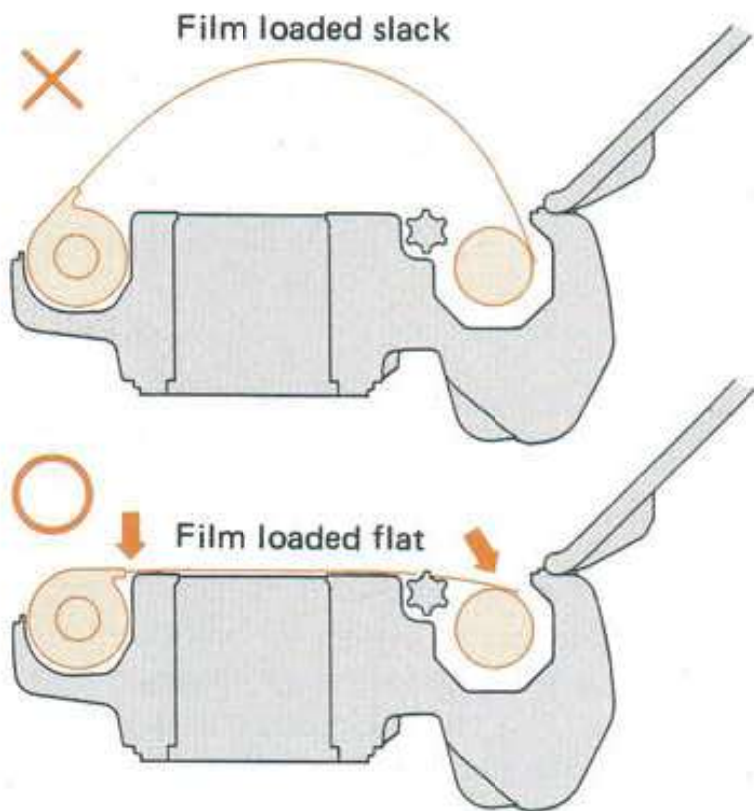

● If the film is slack, push some of the film back into the cartridge to make it flat. If the film is sharply bent, straighten it out or cut off the bent portion.

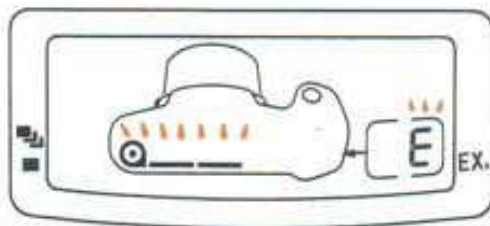

6

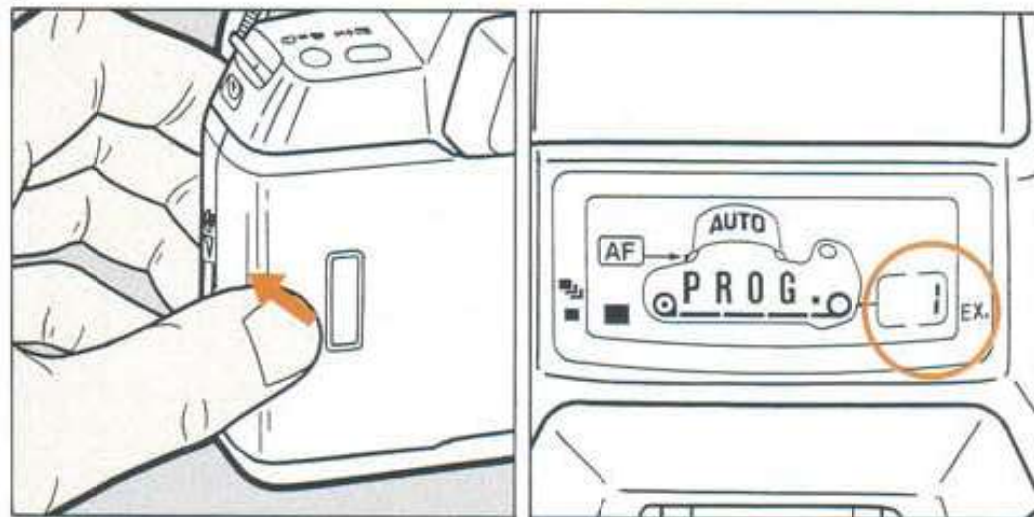

6. Close the back cover, and the camera automatically advances the film to the first frame, indicating the exposure counter "1" in the LCD panel.

- \* Make sure the film-loaded mark [ @\_\_\_\_\_ ] is displayed in the LCD panel.
- \* If the film-advance mark [ @\_\_\_\_\_ ] and the error mark [ E ] are flickering as shown, the film is not properly loaded. It must be reloaded.

## 5. SOFT CASE

1



2

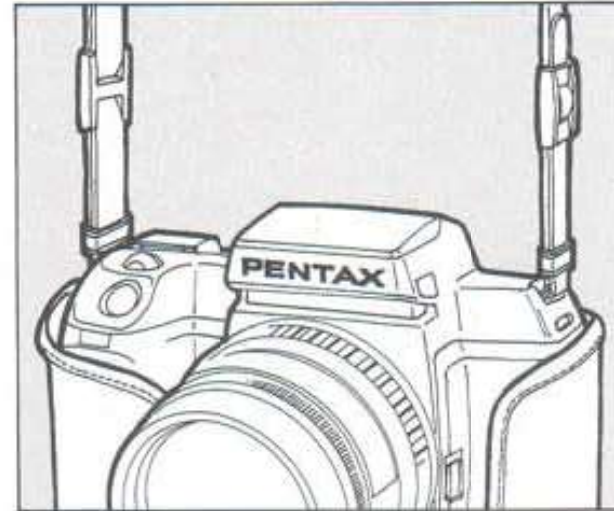
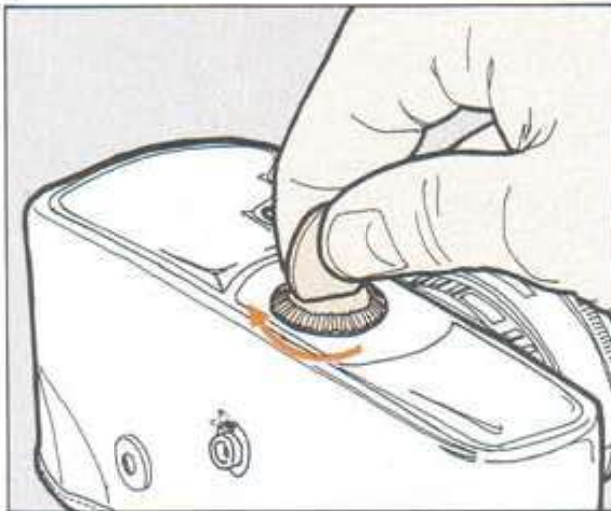

The soft case is available as an option, and consists of a front cover and a back cover.

1. Open up the front cover, and place the camera in the back cover.
2. Secure the camera in the back cover by tightening the fitting screw at the bottom with a coin.

The front cover is available in three sizes: S (Standard), M (Medium) and L (Large). For the lenses that can be contained in each front cover, refer to the table.

Front cover	Lenses
S	50mm f/1.4, Zoom 35–70mm or any other similar-sized lens
M	Zoom 28–80mm, Zoom 35–105mm or any other similar-sized lens
L	Macro 100mm, Zoom 70–210mm or any other similar-sized lens

*Now you have completed preshooting preparations.*

# BASIC OPERATION

1. Operating main switch .....	13
2. Operating shutter-release button .....	13
3. Selecting Programmed AE mode .....	14
4. Selecting single film advance mode .....	16
5. Selecting focus mode .....	16
6. Holding camera & preventing camera shake .....	17
7. Focusing .....	18
8. Using focus-lock function .....	20
9. Using zoom lens .....	21
10. Taking a picture .....	22
11. Shooting with built-in RTF .....	24
12. Using AF spotbeam projector .....	29
13. Rewinding film .....	30



## 1. OPERATING MAIN SWITCH

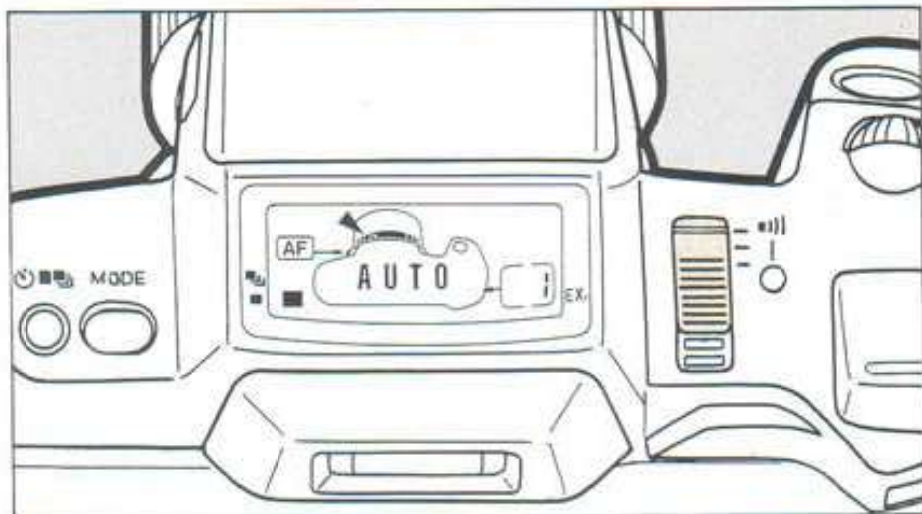

- [ON] [●●] : Signals correct focusing and self-timer operation with PCV tone.  
[ I ] : Cancels PCV signals.
- [OFF] [○] : Be sure to set the main switch at this position when the camera is not in use.

## 2. OPERATING SHUTTER-RELEASE BUTTON

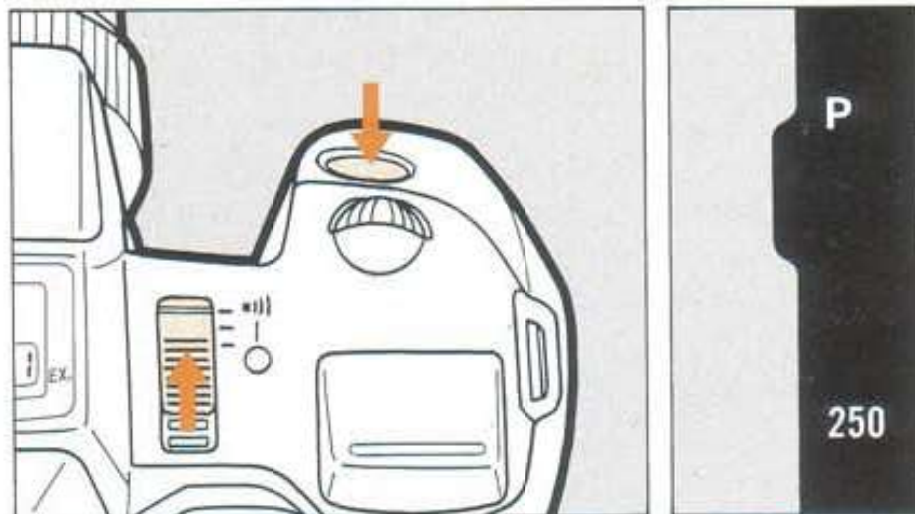

1. Set the main switch at [●●]. While the shutter release button is pressed down lightly, information such as exposure settings is displayed in the viewfinder. Then, when the shutter release button is pressed all the way down, the shutter is released.
- \* If you remove your finger, the viewfinder display will go off after approximately 5 seconds.

### 3. SELECTING PROGRAMMED AE MODE

The Programmed AE mode automatically selects the best combination of aperture and shutter speed, so you can enjoy photography without difficulty.

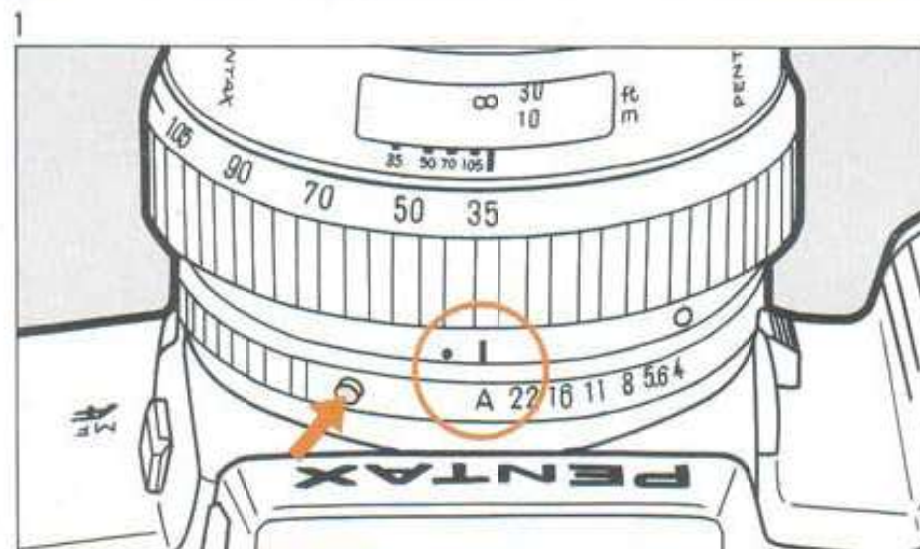
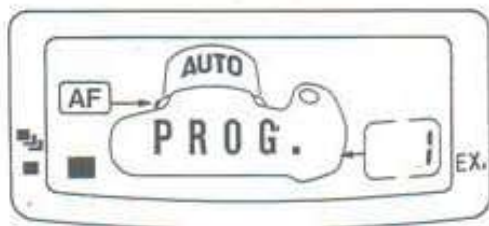

1. Set the lens aperture ring at the [A] position while pressing down the aperture-auto lock button.

\* The aperture ring is locked at the [A] position.

• Note how the indication changes.

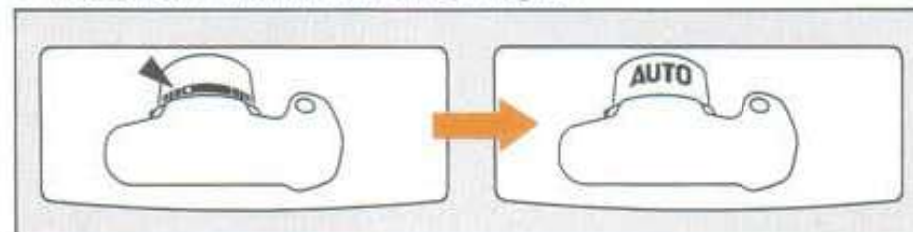

2

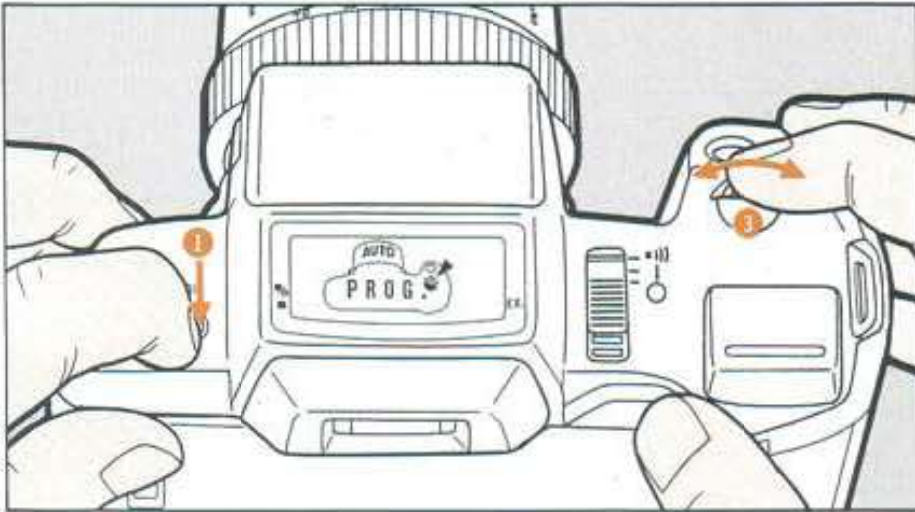

2. Turn the select dial ❶ in either direction while pressing down the mode button ❶ until the mark [PROG] appears in the LCD panel.

\* If the select dial is held down, the mode can be changed more rapidly.

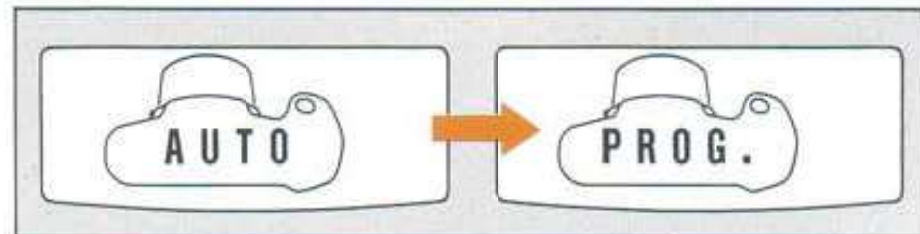

3

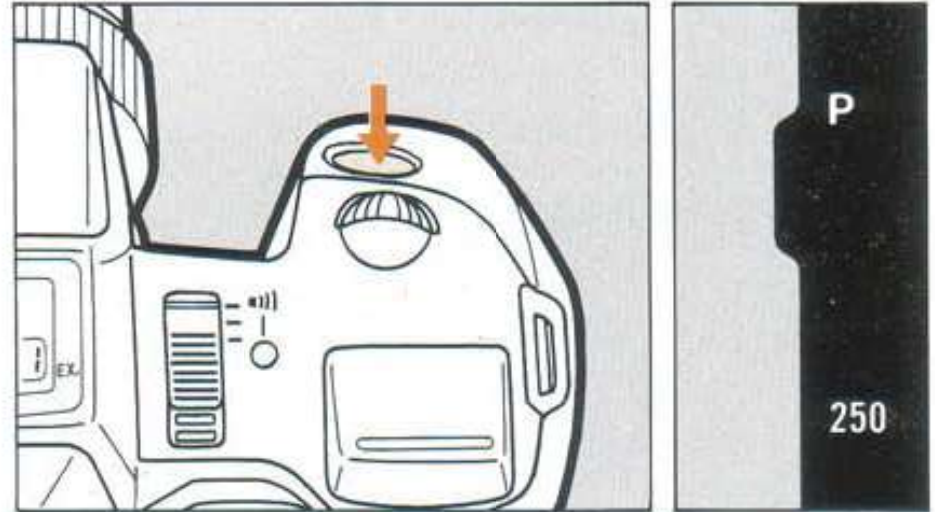

3. Lightly press the shutter release button while looking into the viewfinder to confirm the mark [P] and the shutter speed appearing in the viewfinder display.

\* If a green shutter speed indication between 2000 and 60 (1/2000 sec. to 1/60 sec.) comes on, you can start shooting. When "30" or "LT" glows or flickers in the viewfinder, the selected shutter speed is slow enough to cause camera shake. The use of a flash or a tripod is recommended.

\* When the mark [⚡] blinks, use the built-in RTF (see page 24).

#### 4. SELECTING SINGLE FILM ADVANCE MODE

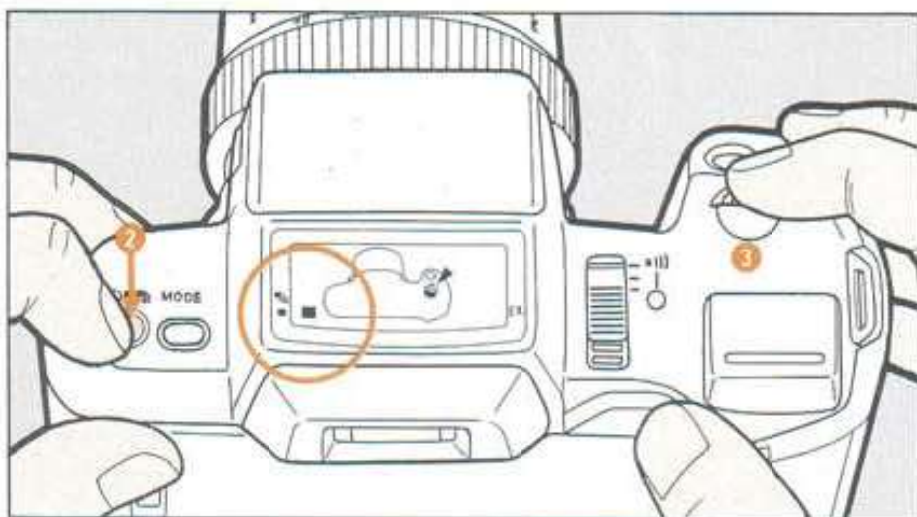

Turn the select dial ① while pressing down the drive button ② until the mark [■] appears in the LCD panel.

[■] **Single film-advance mode:**

You can take a single picture every time the shutter release button is pressed.

[■] **Consecutive film-advance mode:**

You can keep taking pictures consecutively as long as the shutter release button is held down.

[⌚] **Self-timer mode:**

A self-timer is activated when the shutter release button is pressed and a picture is taken automatically after approximately 12 seconds.

#### 5. SELECTING FOCUS MODE

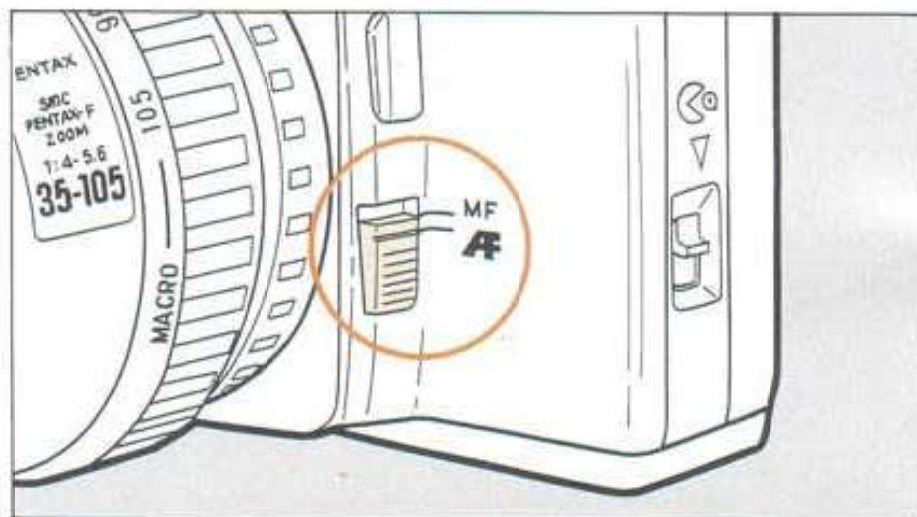

Set the focus-mode switch to the auto-focus position indicated by a red [AF] mark.

[AF] : The camera automatically sets the correct focus by adjusting the lens.

[MF] : Focusing is manually adjusted by turning the focusing ring (see page 40).

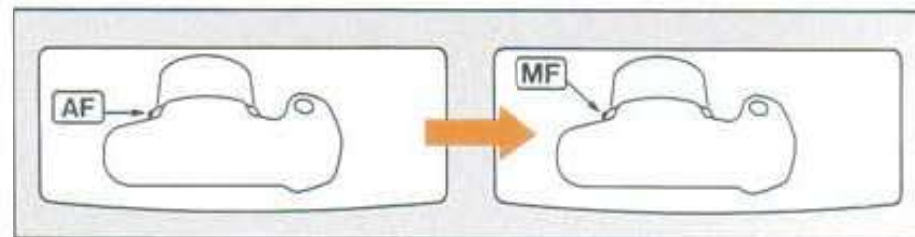

## 6. HOLDING CAMERA & PREVENTING CAMERA SHAKE

It is important to hold the camera firmly and properly.

- When taking a picture, hold your breath and press down the shutter release button gently with your fingertip. (Pressing down the shutter release button forcefully can cause camera shake.)
- Stabilize your body and camera by using some object, such as a tree, building or table.
- When photographing with a slow shutter speed or a super telephoto lens, it is recommended to use a tripod and an optional Cable Switch F.
- Especially when using a super telephoto lens with a tripod, use of a tripod heavier than the total weight of camera and lens is an effective means to minimize camera shake.

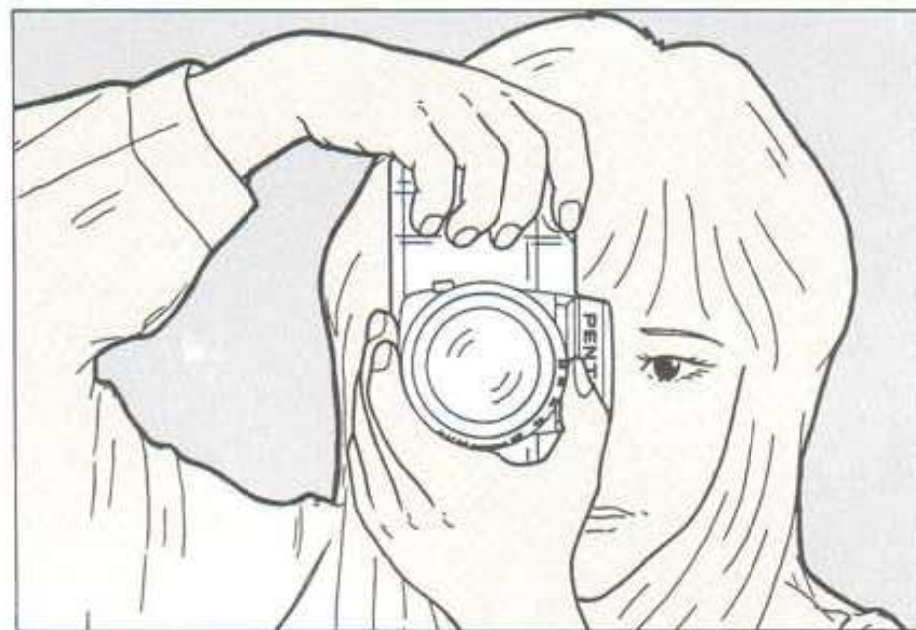

## 7. FOCUSING

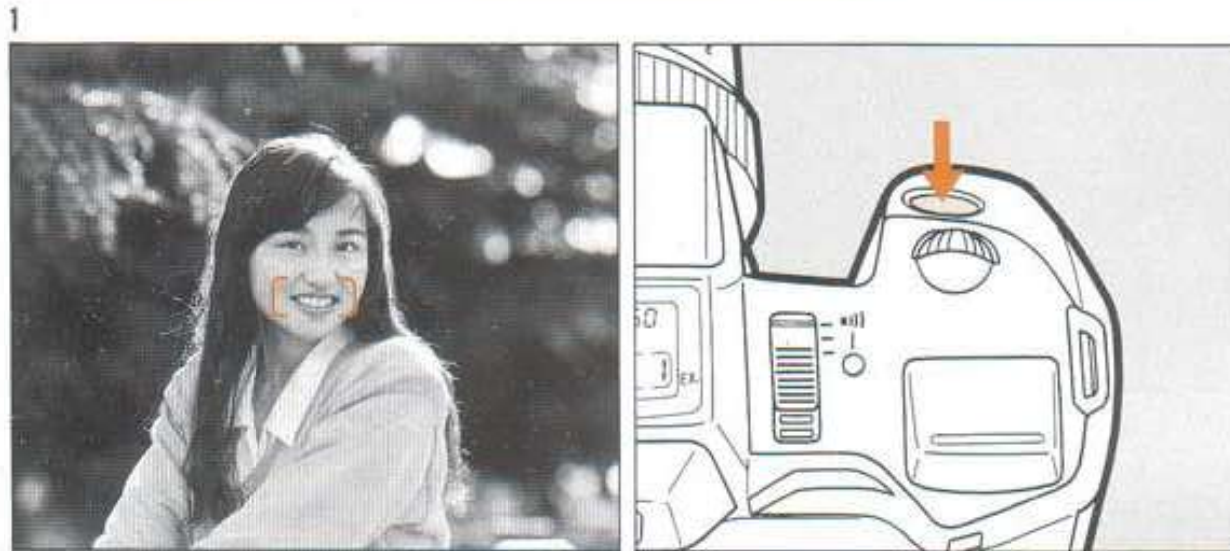

1. Position the subject in the auto-focus frame in the viewfinder and lightly press the shutter release button.

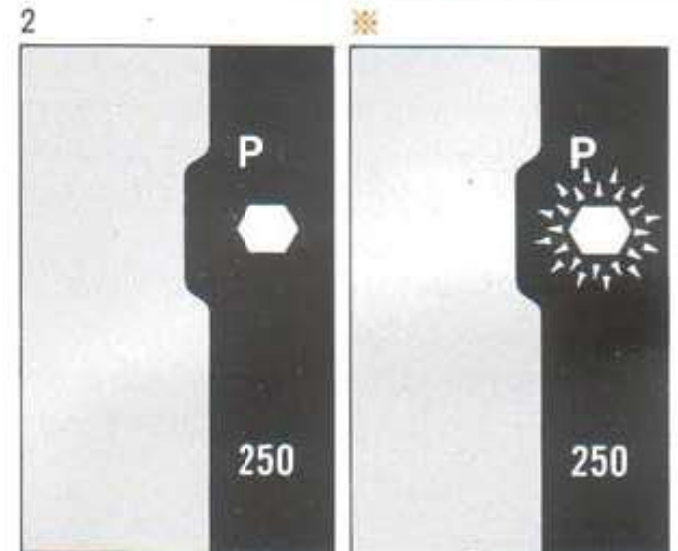

2. When the subject is captured in focus, a green in-focus signal [  ] comes on in the viewfinder and a PCV tone confirms it audibly.

※ If the in-focus signal [  ] blinks, the subject is too close or is difficult to focus on (see page 42).

### Note:

- The shutter can be released only when the subject is in focus.
- Once the subject is captured in focus, focusing is locked. In order to take a different subject, remove the finger from the shutter release button, then press it down again.

3



3. The shutter is released by pressing the shutter release button all the way down.

※

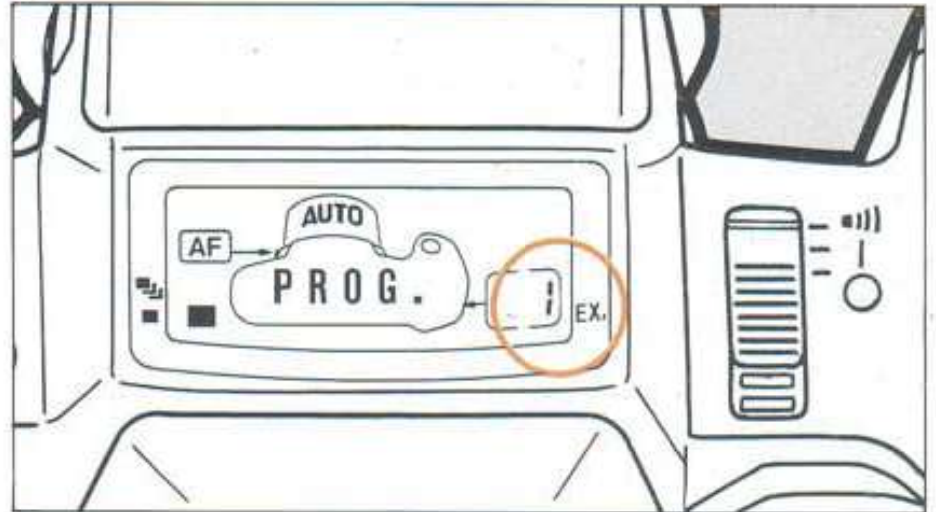

- ※ The figure indicated in [EX.] is the exposure number. It increases by one each time the shutter is released.

## 8. USING FOCUS-LOCK FUNCTION



When you wish to position the subject away from the auto-focus frame [C ] for your image composition, use the following procedures to lock the focus.

1. If you take a picture with the auto-focus frame positioned away from the subject, the focus is automatically set on the background (see photograph).
2. Aim the auto-focus frame at the subject, press the shutter release button lightly and keep the green in-focus signal on by holding it at that position. (This makes the camera memorize the correct focus.)
3. Move the camera back to the original composition while holding the shutter release button at the same position, then press it all the way down to take a picture.

- As long as you hold the shutter release button half-way down and the green in-focus signal is on, the focus remains locked. When you remove your finger, it is unlocked. This procedure can be repeated any number of times.



## 9. USING ZOOM LENS



When the zoom ring is rotated, an image becomes larger or smaller, so you can find the image size you like best.

- \* Smaller figures on the zoom ring indicate wide-angle settings to cover more image area while larger figures are telephoto settings to take larger images of distant subjects.



## 10. TAKING A PICTURE

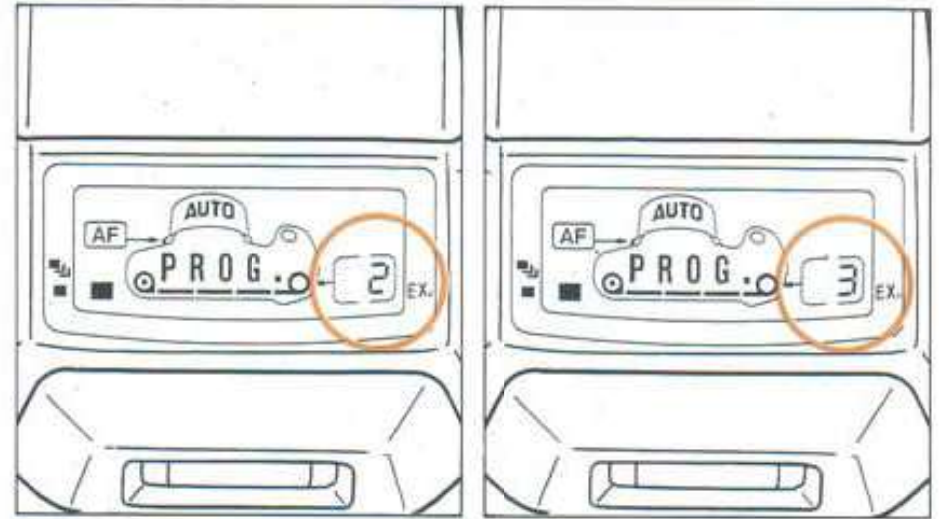

Press the shutter-release button gently to release the shutter. The film is automatically transported to the next frame.





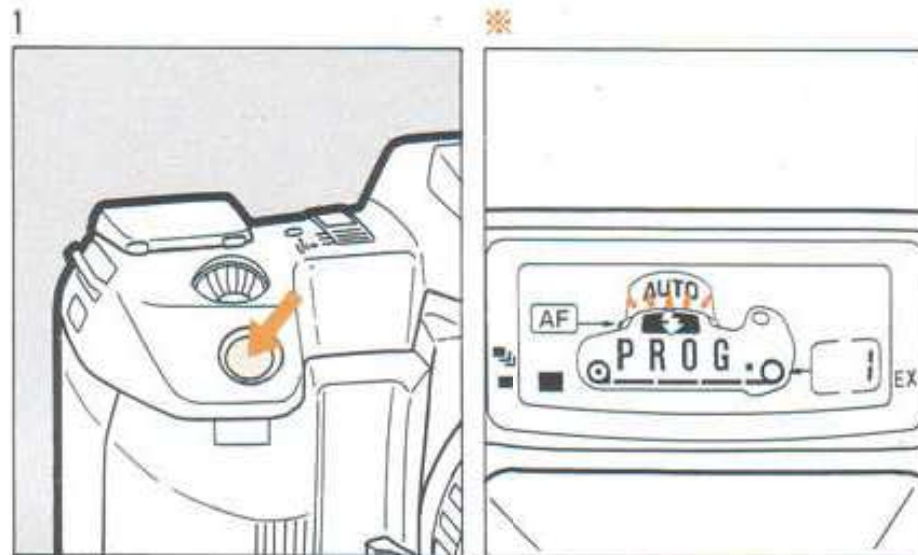

## 11. SHOOTING WITH BUILT-IN RTF

### (1) Using the Programmed Auto Flash mode



In low light or backlit situations, the camera's Programmed Auto Flash mode automatically selects the best combination of shutter speed and aperture according to lighting conditions, making flash photography accurate and easy. Lenses with focal lengths between 35mm and 210mm (with the exception of macro lenses) can be used in this mode.

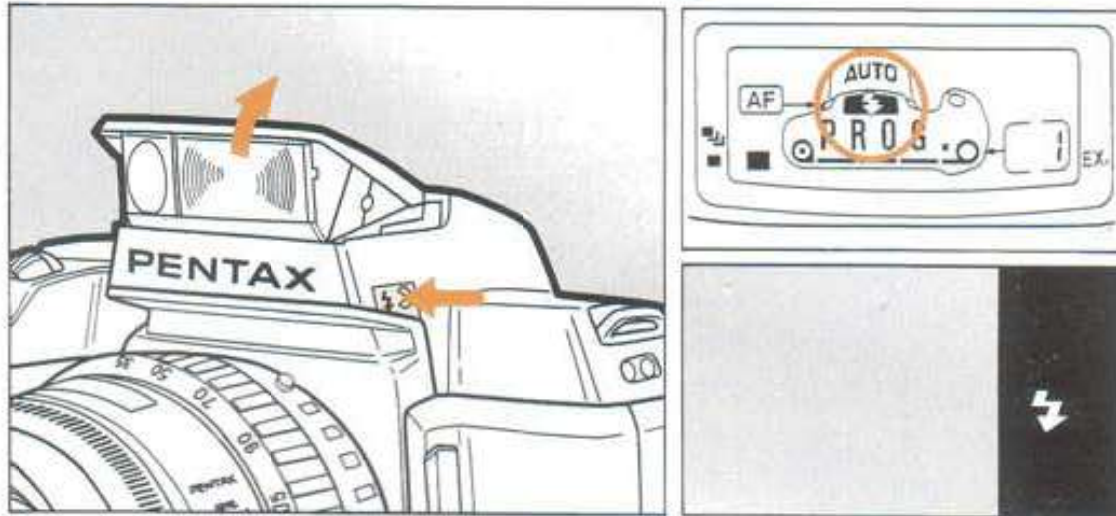

1. Set the camera to Programmed AE mode and lightly press the shutter release button.
- ✱ In low light and backlit situation, the flash marks both in the LCD panel [  ] and viewfinder [  ] will blink. (These are "flash recommendation signals" advising you to use the RTF.)
- 
- ✱ The Programmed Auto Flash mode can also be used in the camera's Shutter-Priority AE mode (see page 36). In backlit situations, the flash marks [  ] and [  ] blink to recommend use of the RTF.

2



2. Remove your finger from the shutter release button. Push the yellow flash pop-up switch [  ] to expose the RTF above the pentaprism.
- ※ The RTF starts charging automatically. When charging is completed, the flash mark [  ] comes on in the LCD panel and also the flash mark in the viewfinder [  ] lights up when the shutter release button is pressed lightly. (The flash recycle time is approximately 4 seconds.)

3



3. Press the shutter release button all the way down to take a picture.

**Note:**

- When shooting is finished, be sure to put the RTF back into the original storage position.
- While the RTF is in the pop-up position, a small amount of electric current is constantly supplied to recharge it. So, when not in use, be sure to keep it in the storage position to save the battery.

● **Effective flash range in Programmed Auto Flash mode**

Maximum aperture	Effective range
f/1.4 – 2.8	0.9m – 4.3m
f/4	0.7m – 3m
f/5.6	0.7m – 2.1m

**Note:** The effective flash range (from the film plane to the subject) differs depending on the maximum aperture (the smallest f-number) of the lens in use.



**[Technical Tip] How to determine the maximum aperture**

If the marking on your lens reads “SMC PENTAX-F ZOOM 1:4–5.6 35–105,” for example, it has a maximum aperture of f/4 at the focal length of 35mm and f/5.6 at 105mm.

**Operational precautions**

1. While the RTF is being charged, keep your finger off the shutter release button.

2. **RTF flash warning**

When using the lenses listed below, the camera’s safety mechanism warns against use of the RTF; flash marks in the LCD panel [  ] and viewfinder [  ] begin to blink when the shutter release button is lightly pressed at the completion of flash charge. In this case, even if the shutter release button is pressed, the RTF will not discharge and the camera is automatically switched to the normal shooting mode.

- Lenses with a focal length of less than 35mm.
- Lenses with a focal length of over 210mm.
- Macro lenses.

The purpose of this warning is to prevent vignetting at four corners of a picture due to lack of illumination or semicircular vignetting at the bottom of a picture due to the lens blocking the illumination path of the RTF. Since this mechanism is activated only in combination with F-series lenses (lenses with the marking of SMC PENTAX-F), no warning appears in combination with other lenses, so care is advised when using lenses other than F-series lenses.

3. When taking photographs with both close and distant subjects in the same frame, selecting an aperture for the distant subject may cause overexposure of the closer subject (washed-out appearance) due to excessive illumination.
4. Do not use a lens hood. The RTF's discharge may be cut off. This may also happen in the photography within the distance of 1 m when a 35mm wide-angle lens is mounted.
5. **To prevent "red-eye effect":**  
The so-called "red-eye effect" is a phenomenon in which the flash illumination reflects off the retina because the pupil opens up in darkness. It is impossible to prevent it but it can be minimized by lighting up the location (to close down the subject's pupils) or, in case of a zoom lens, by moving closer to the subject using a wide-angle setting.
6. In the daylight flash-sync photography, over exposure may occur when a subject's environment is too bright.



## (2) Using a manual aperture setting:

(Please read this section after you finish reading the "OPERATION OF MAJOR FUNCTIONS" section.)

When you wish to increase the depth of field, you can manually select a desired aperture. In order to select an aperture manually, the camera must be set in the Aperture-Priority AE mode (see page 38) or the Metered Manual mode (see page 40).

### Flash recommendation signals

	Poor lighting	Backlighting
Aperture-Priority AE	○	○
Metered Manual	X	○

To calculate the effective RTF range with the selected aperture, the following formula can be used:

- Maximum distance:  $(\text{G.N.}) \div (\text{aperture})$
- Minimum distance:  $(\text{Maximum distance}) \div 5$   
(This formula cannot be used for a subject closer than 0.7 meters.)

If the subject distance is known beforehand, calculate the aperture based on that distance.

- $(\text{G.N.}) \div (\text{distance}) = (\text{aperture})$
- \* If the aperture calculated by this formula does not correspond to any f-number found on the aperture ring (for example, the aperture "3," which is between "4" and "2.8"), set the aperture to the smaller f-number ("2.8").

The RTF's guide number (G.N.) varies according to the ISO speed of the film in use, as indicated in the chart below.

ISO film speed	Guide number
ISO 25	G.N. 6
ISO 50	G.N. 8.5
ISO 100	G.N. 12
ISO 200	G.N. 17
ISO 400	G.N. 24

To use the RTF at aperture f/4 with ISO 100 film:

1. Set the lens aperture ring to f/4.
2. Calculate an effective flash range.  
 $12 (\text{G.N.}) \div 4 (\text{aperture}) = 3\text{m}$  (maximum distance)  
 $3\text{m} (\text{distance}) \div 5 = 0.6\text{m}$  (minimum distance) → 0.7 (actual minimum distance)



## 12. USING AF SPOTBEAM PROJECTOR

3. Therefore, the effective flash range is between 0.7 meters and 3 meters.

### Specifications of the RTF

(at ISO 100)

Guide number (G.N.):	12
Recycle time:	Approx. 4 seconds
Usable film speed:	ISO 25 – ISO 400
Effective flash range:	Approx. 0.9m – 4.3m (at f/2.8)
Usable lenses:	From 35mm to 210mm. 35mm lenses usable at 1 meter or farther. Excluding macro lenses.

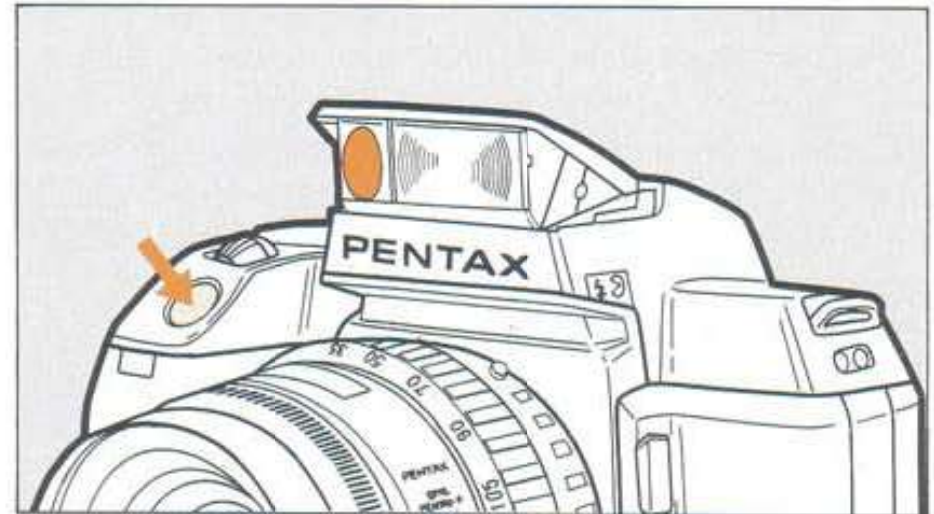

When the RTF is used in the dark, a red beam called the “AF spotbeam” is automatically projected to assist the camera’s auto-focus mechanism.

#### Note:

The spotbeam is activated only when the KAF mount lens or the AF adapter is mounted and the Focus mode switch is set at [AF].

- The effective range of the AF spotbeam is approximately one to four meters. If you do not wish to use the RTF, put it back into the storage position after setting the focus on the subject using the focus-lock function.
- The AF spotbeam does not work in well-lit locations.
- If in-focus signal [  $\square$  ] in the viewfinder is blinking, the camera is unable to focus on the subject.
- When an AF spotbeam of the AF400FTZ or AF240FT is used, the RTF’s spotbeam is inactivated.

## 13. REWINDING FILM

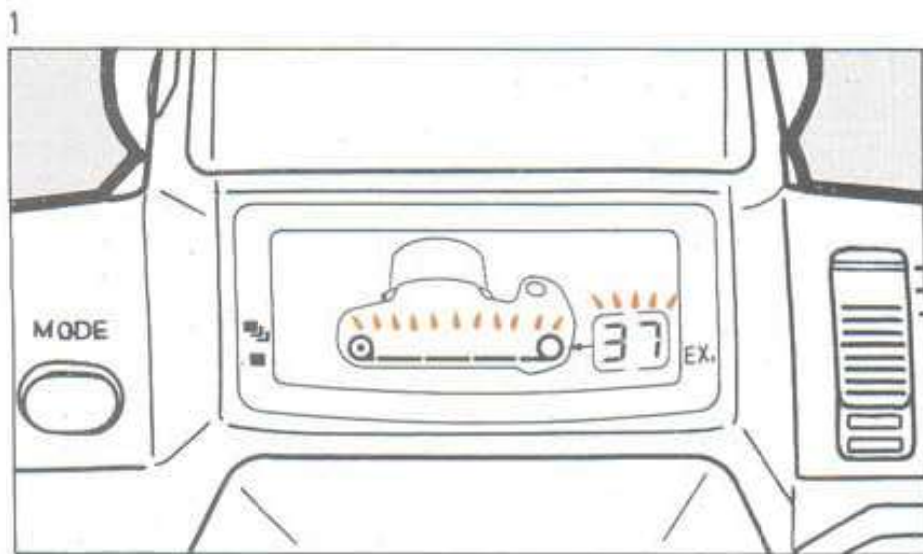

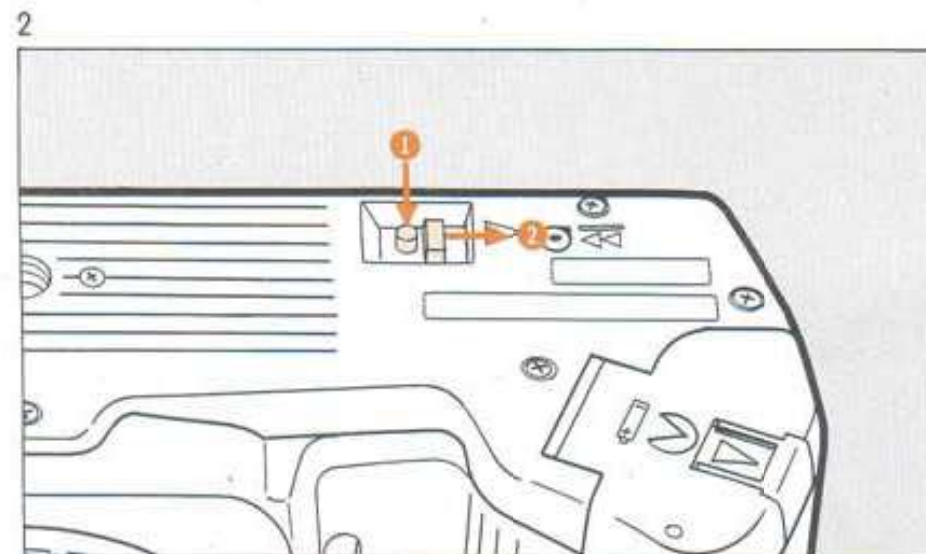

1. When the film is used up, the end-of-film mark [ —○ ] and the figure in the exposure counter [ EX. ] blink.

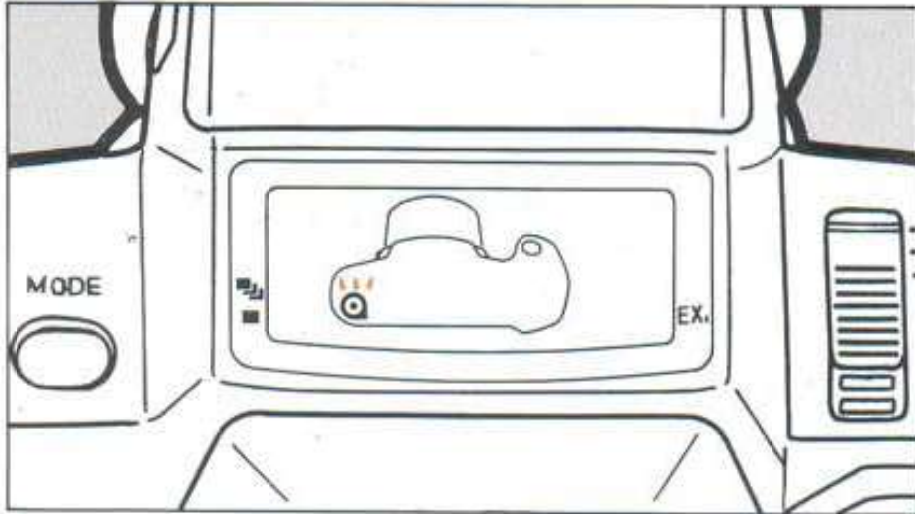

2. Push the rewind switch ② toward the mark [ ▶ ] until it click-stops while pressing down the rewind button ①, and the camera starts rewinding the film. (The figure in the exposure counter decreases as well.)

3



3. When rewind is completed, the film mark [  ] blinks and the figure in the exposure counter [ EX. ] goes off.

4

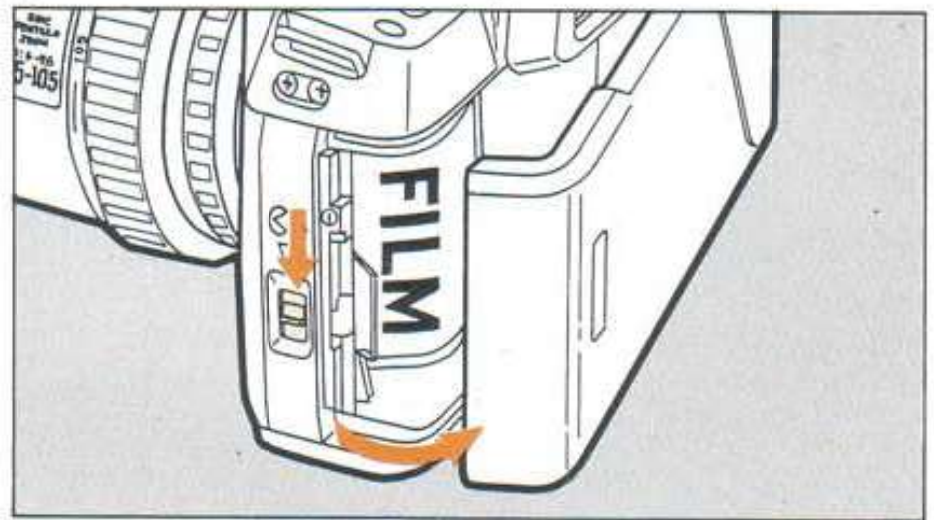

4. Open the back cover and take the film out.

- When you finish shooting, be sure to set the main switch to the "OFF" mark [  ] to turn the power off.

*Now you have mastered the camera's basic operations.*

# OPERATION OF MAJOR FUNCTIONS

Exposure modes using F-series lenses .....	33
Using Shutter-Priority AE mode .....	36
Using Aperture-Priority AE mode .....	38
Using Metered Manual mode .....	40
Difficult subjects for auto focusing .....	42
Manual focusing .....	43
Using exposure memory lock function .....	44
Using self-timer .....	45

## EXPOSURE MODES USING F-SERIES LENSES

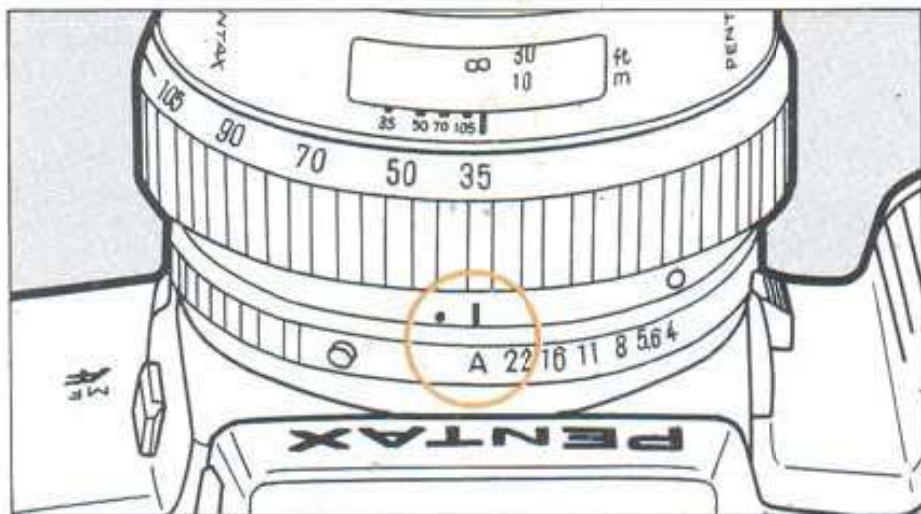

If you use an F-series lens in combination with this camera, you can employ the following exposure modes, in addition to the Programmed AE mode, according to the position of the aperture ring. To set the lens aperture at [A] or any other f-stop, turn the aperture ring while depressing the aperture-A-lock button.

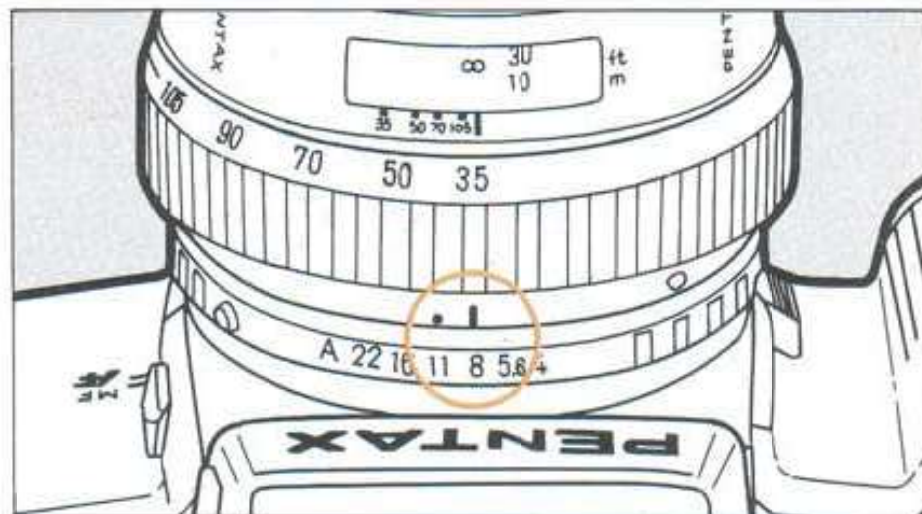

- [A]      • Programmed AE  
          • Shutter-Priority AE
- [Manual] • Aperture-Priority AE  
          • Metered Manual  
          • Bulb [B]

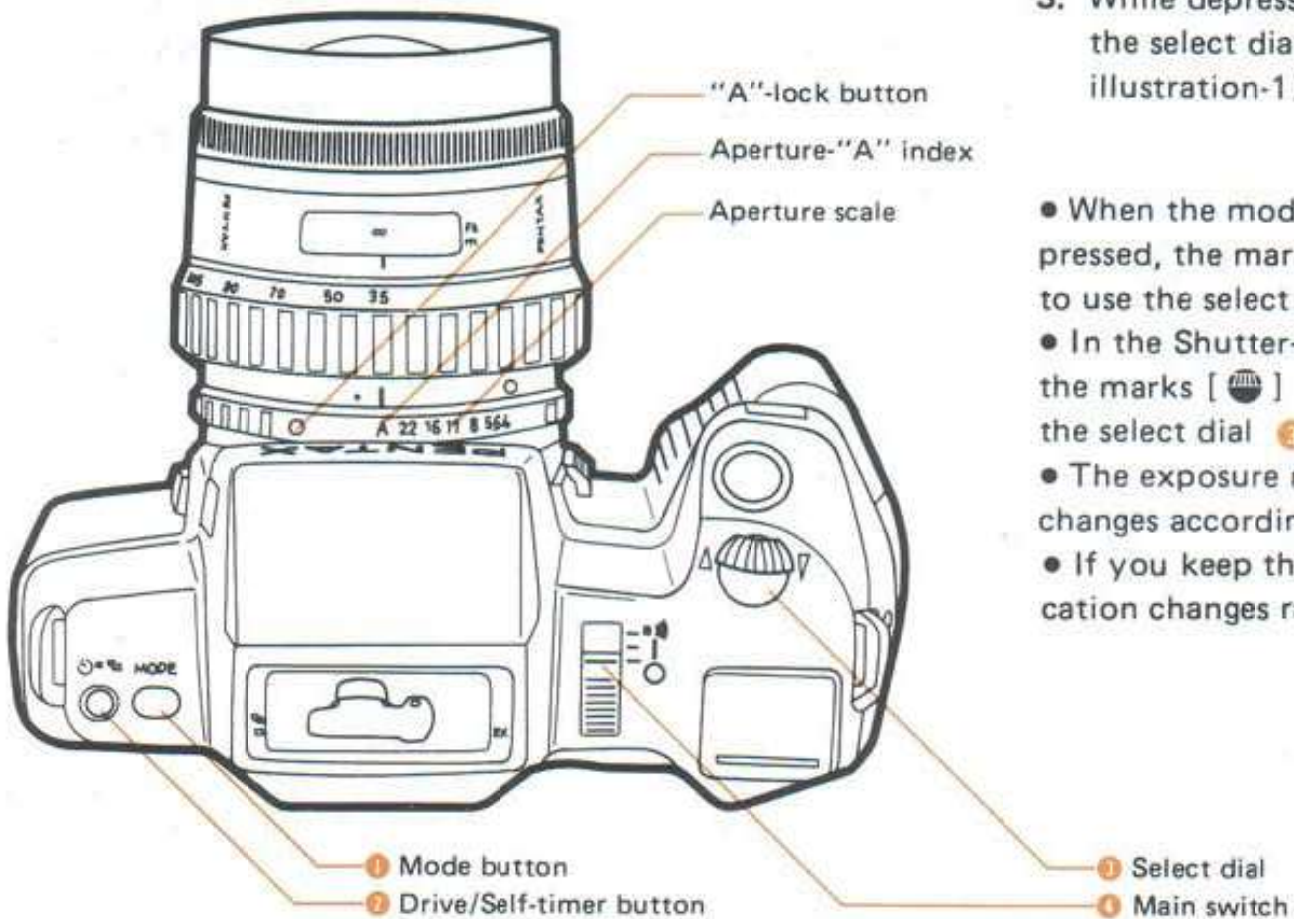

### How to select an exposure mode:

1. Set the lens aperture ring at either [A] or any f-number other than [A].
2. Turn the main switch on to either the [●] or [I] position.
3. While depressing the grey mode button ①, turn the select dial ③ either to the right or left. (see illustration-1)

- When the mode button ① or the drive button ② is pressed, the marks [●] and [▲] blink to instruct you to use the select dial ③ next.
- In the Shutter-Priority AE and Metered Manual modes, the marks [●] and [▲] appear to instruct you to use the select dial ③ next.
- The exposure mode indication in the LCD panel changes according to the chart.
- If you keep the select dial ③ turned, the LCD indication changes rapidly.

### When aperture ring set at "A"

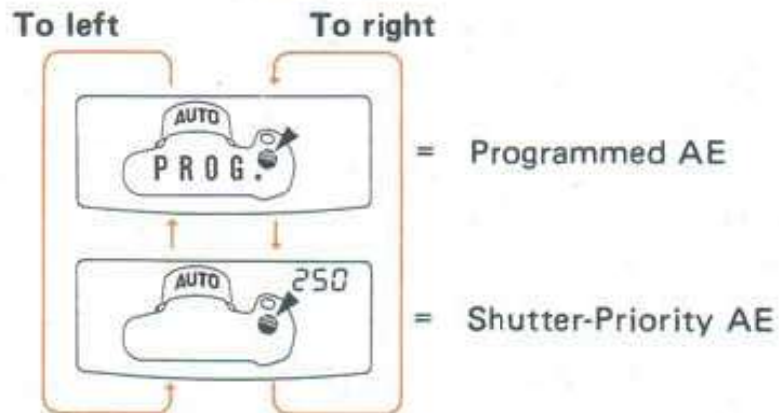

### Exposure Control System

In the Programmed AE mode, Aperture priority AE mode and Shutter speed priority AE mode, the PROCES (Progressive Contrast Compensation Exposure System) judges adverse lighting conditions such as backlight situation and automatically adjust the exposure.

In the Metered manual mode and Exposure lock mechanism, the exposure metering system is automatically changed to TTL central area metering. Thus, the accurate exposure control can be easily done.

### When aperture ring set at any f-number other than "A"

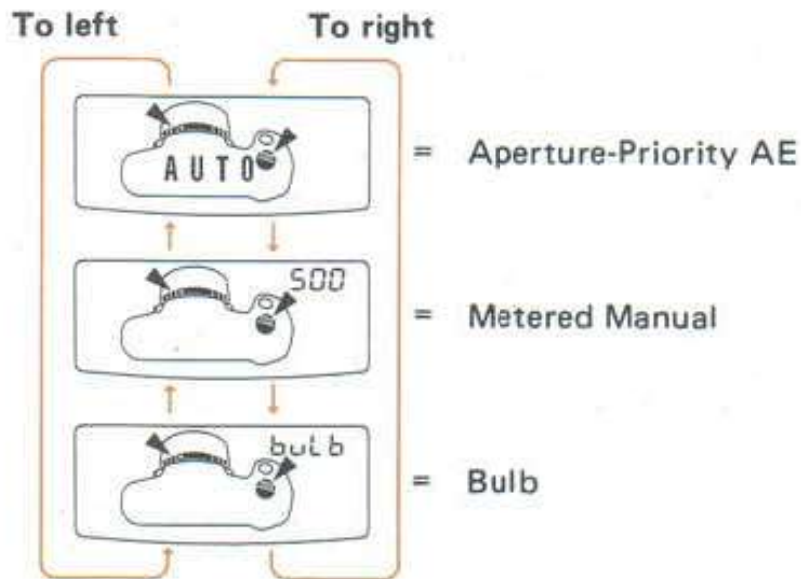

## USING SHUTTER-PRIORITY AE MODE

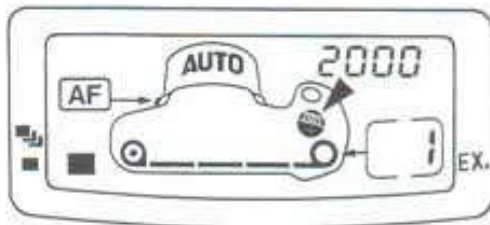

### Shutter-Priority AE mode

When you select a shutter speed, the camera automatically sets a corresponding aperture, according to lighting conditions, for the best exposure. This mode is especially useful in freezing the action of a fast-moving object with a fast shutter speed or emphasizing motion using a slow shutter speed.

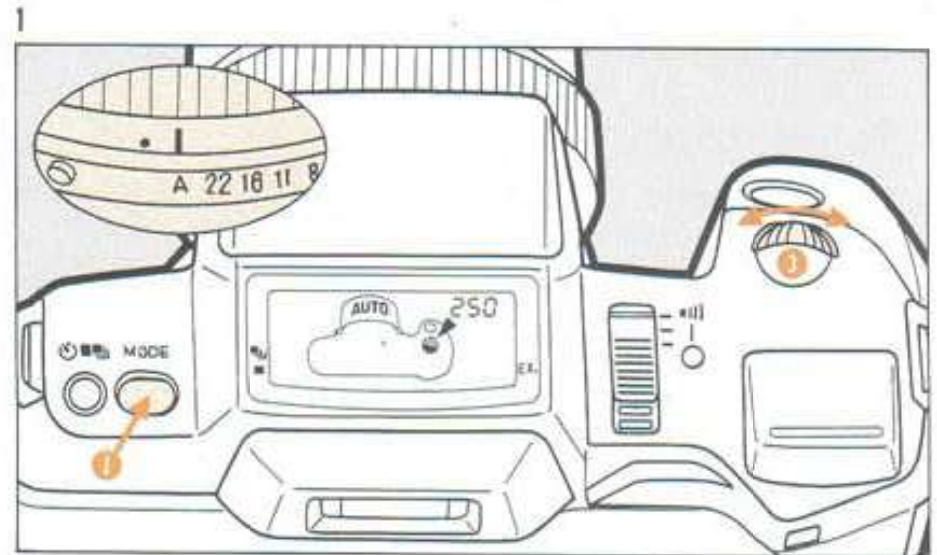
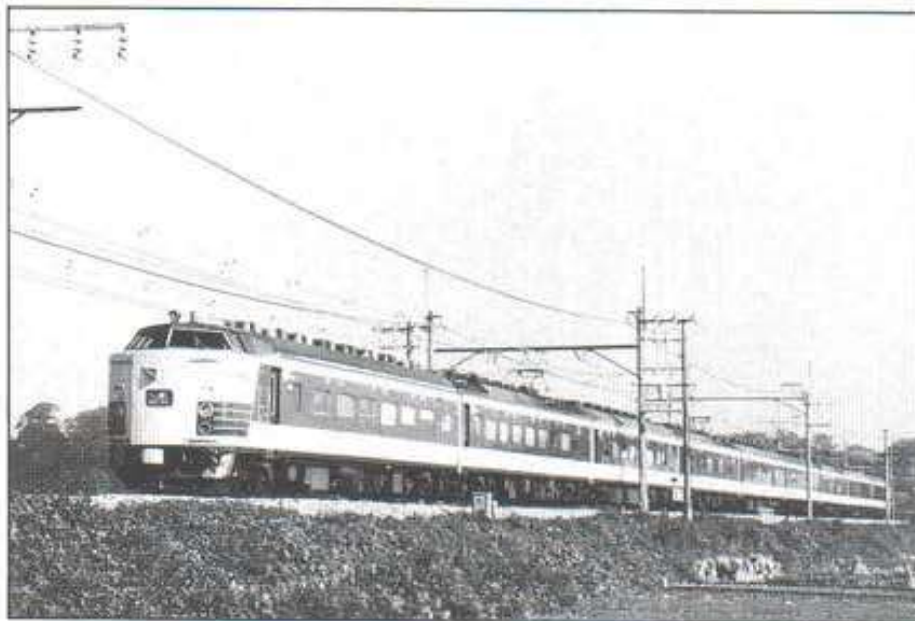

The [  ] indication appears and tells you to turn the select dial to select the shutter speed.



1. Set the aperture ring to [A]. Select the Shutter-Priority AE mode by turning the select dial  while pressing down the mode button  until the [AUTO] indication and shutter speed appear in the LCD panel.



2

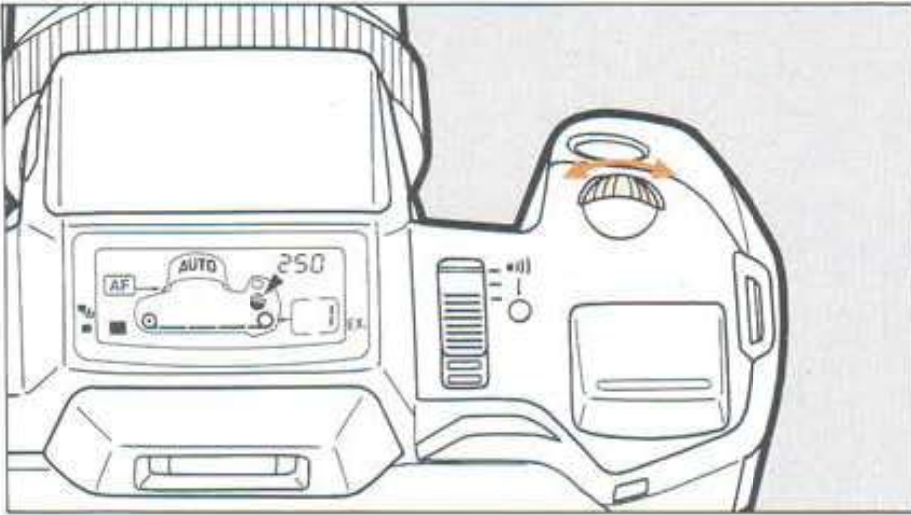

2. Select a desired shutter speed. Turn the select dial to the left for faster shutter speeds or to the right for slower ones, and by keeping it turned, you can rapidly change the indication.
- \* The shutter speeds from "2000" (1/2000) to "1" (one second) are displayed in the LCD panel.

**Note:** When "30" or "LT" glows or flickers in the viewfinder, the selected shutter speed is slow enough to cause camera shake. The use of a flash or a tripod is recommended.

3

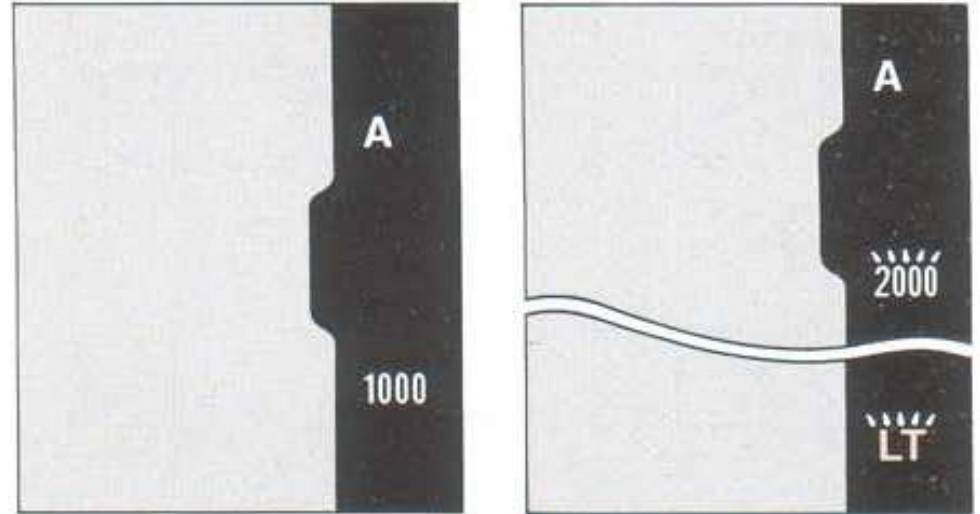

3. When the shutter release button is pressed lightly, the [A] indication and a selected shutter speed are displayed in the viewfinder. When the selected shutter speed is 1/15 – 1 sec., "LT" glows in the viewfinder.
- \* **Note: Out-of-meter-coupling-range warning**  
If the subject is too bright or too dark, the viewfinder indication blinks in warning.  
If the blinking goes off after shifting the shutter speed to a slower (toward "LT") or faster (toward "2000") setting, you are ready to shoot.

## USING APERTURE-PRIORITY AE MODE

### Aperture-Priority AE mode

This mode is useful when you wish to increase the depth of focus for landscapes, group snapshots and macro photos, or reduce it to take the background out of focus and emphasize the subject.



The [  ] indication appears and tells you to select a desired aperture.

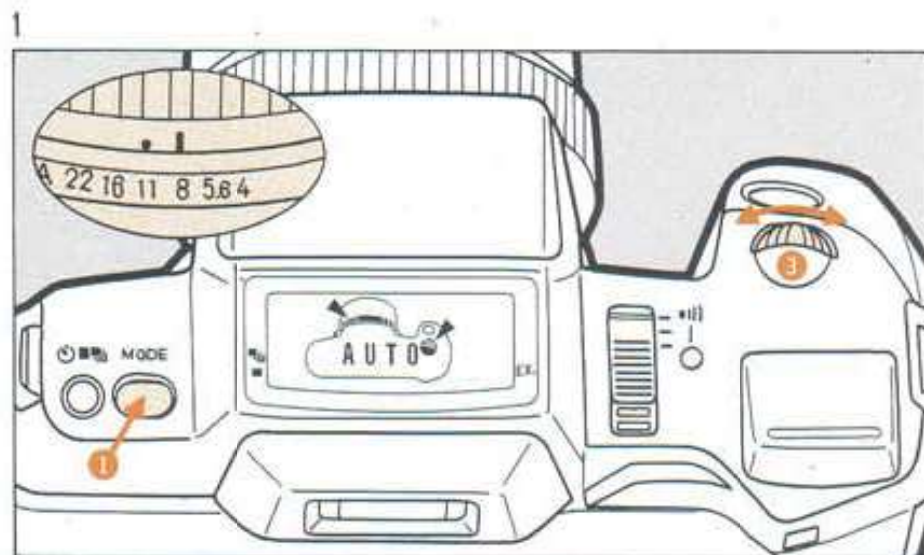

1. Select the Aperture-Priority AE mode by turning the select dial ① while pressing down the mode button ② until the [AUTO] indication appears in the LCD panel.



2

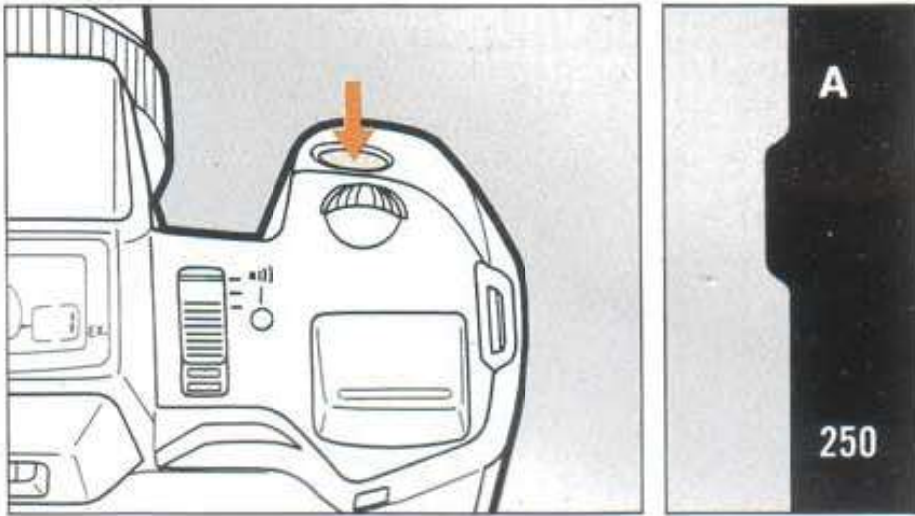

2. When the shutter release button is pressed lightly, the [A] indication and a shutter speed appropriate to the selected aperture are displayed in the viewfinder. When the shutter speed is  $1/15 \sim 1$  sec., "LT" glows or flickers.

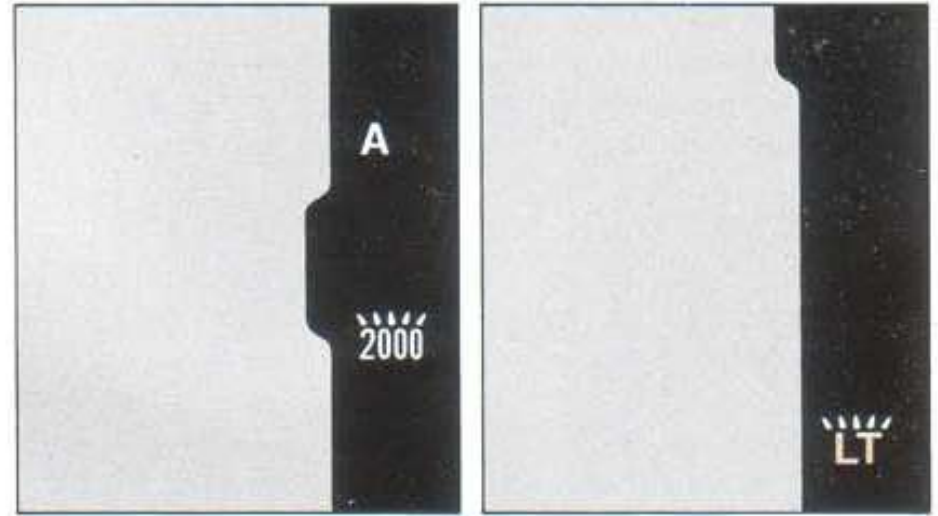

**Note: Out-of-meter-coupling-range warning**

If the subject is too bright or too dark, the viewfinder indication blinks to warn of extraordinary lighting conditions.



If the blinking goes off after turning the aperture ring either to a smaller aperture (a larger f-number, such as f/22) or to a larger one (a smaller f-number, such as f/1.4), you are ready to shoot.

## USING METERED MANUAL MODE

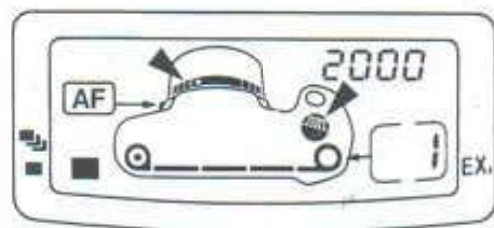

### Metered Manual mode

You can not only obtain a correct exposure by shifting the shutter speed and aperture according to the reading on the exposure meter, but you can also adjust the exposure for creative use.

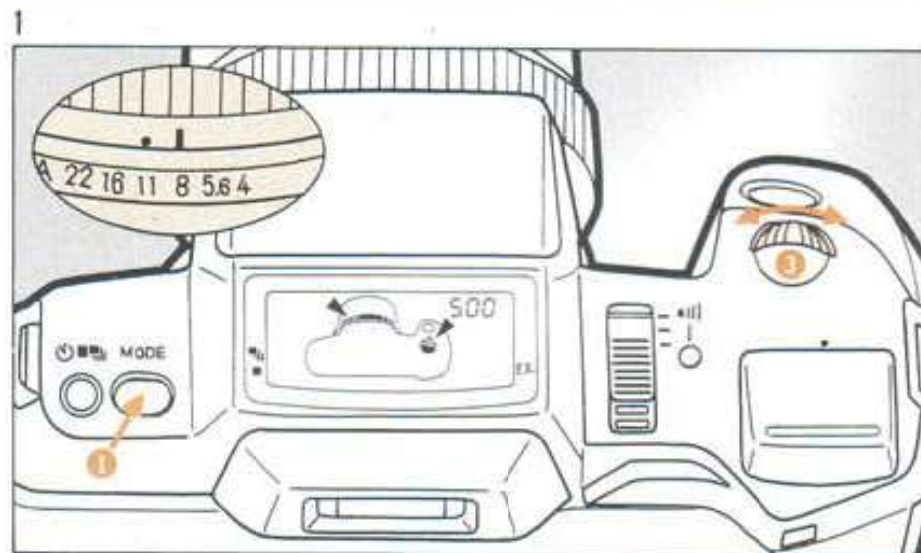

The [  ] and [  ] indications appear, telling you to select an aperture and a shutter speed.



1. Select the Metered Manual mode by turning the select button  while depressing the mode button  until a shutter speed indication appears in the LCD panel.

2

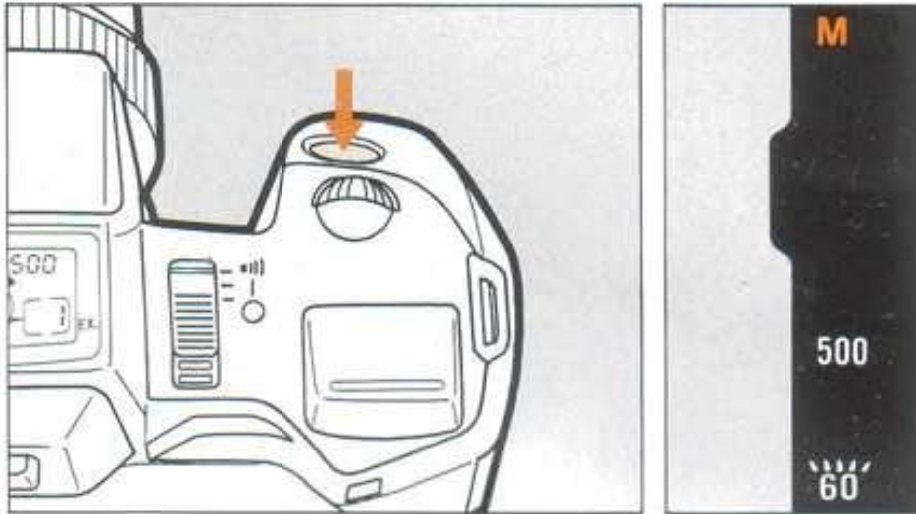

2. When the shutter release button is pressed lightly, the [M] indication and a shutter speed appear in the viewfinder. When the shutter speed is  $1/15 \sim 1$  sec., "LT" glows or flickers.

For example, if a blinking shutter speed indication appears, the exposure is incorrect. Shift the shutter speed or turn the aperture ring until the blinking indication goes off and a solid shutter speed indication appears.

- If a correct exposure cannot be obtained by turning the aperture ring, select another shutter speed.
- If a correct exposure cannot be obtained by shifting the shutter speed, select another aperture.

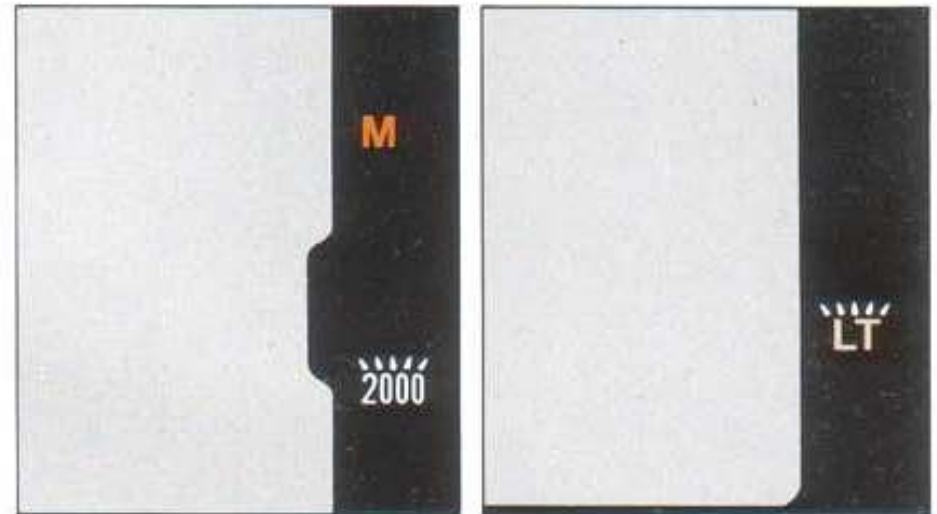

**Note: Out-of-meter-coupling-range warning**

If the subject is too bright or too dark, the viewfinder indication blinks to warn of extraordinary lighting conditions.

If the blinking goes off after turning the aperture ring either to a smaller aperture (toward a larger f-number such as f/22) or to a larger one (toward a smaller f-number such as f/1.4), you are ready to shoot.

## DIFFICULT SUBJECTS FOR AUTO FOCUSING

This camera's auto-focusing system is extremely precise and highly sophisticated, yet there are certain types of subjects (due to their brightness, contrast, shape and size) that make focusing very difficult. For these situations, use the focus lock or manual focusing, or take advantage of the built-in RTF (Retractable TTL-Auto Flash) in dark locations.

- Extremely low-contrast subjects (little difference between the bright and dark areas), such as a white wall.
- Extremely dark subjects.
- Extremely fast-moving subjects.
- Subjects with only horizontal lines.
- Subjects with detailed and/or complex patterns.
- Subjects positioned against harsh reflected light, strong backlight or an extremely bright background.
- Subjects composed of elements both near and far within the focus frame.

### Accessories Not Usable in Auto Focusing

The following accessories cannot be used in the auto-focus mode or the FI (Focus Indication) system. Use the matte area of the viewfinder for focusing.

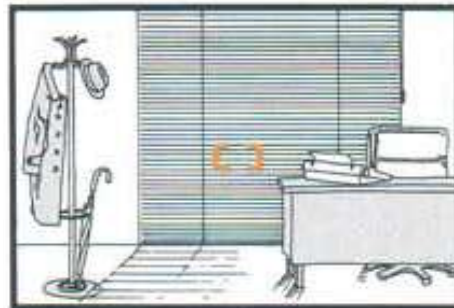

- Special-effect filters, magic-image attachments or stereo adapters.
- The ordinary polarizing filters because this camera has a half-mirror. Use the circular polarizing filters.
- Extension Tubes and Auto Bellows.

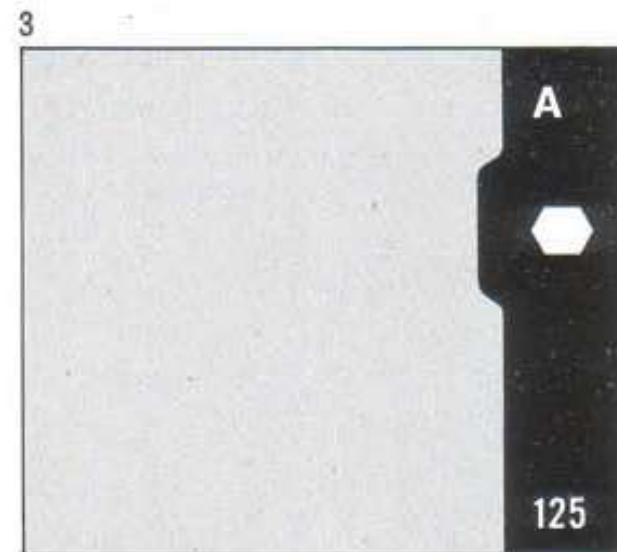
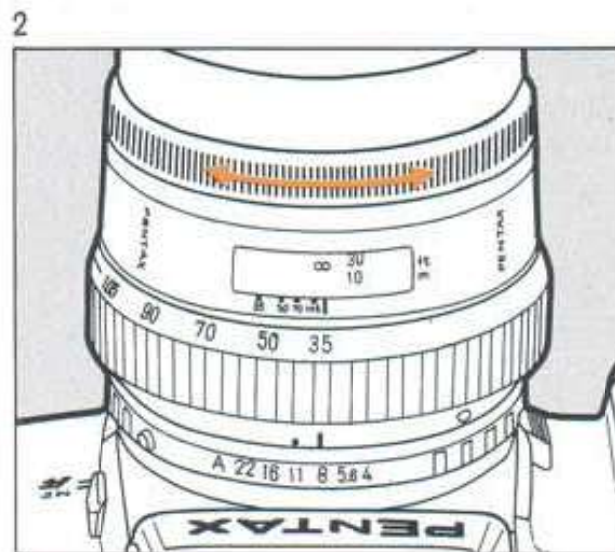
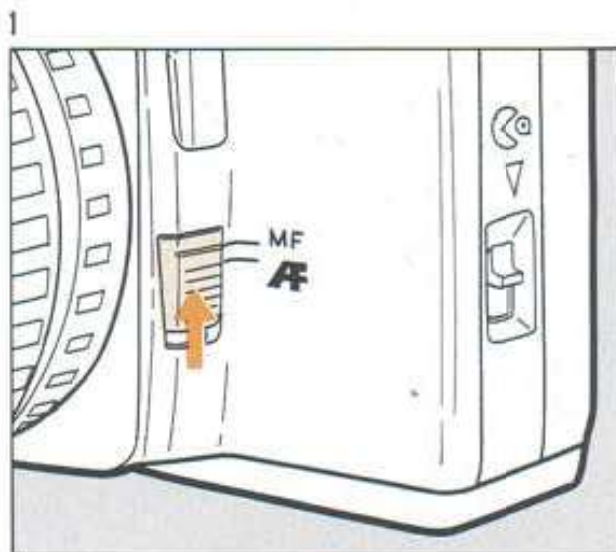

## MANUAL FOCUSING



For conventional Pentax K-mount lenses with a maximum aperture of  $f/5.6$  or larger, you can take advantage of the Focus Indication (F.I.) system in manual focus by positioning the subject in the auto-focus frame. This manual focusing method can also be used with F-series lenses.

1. Set the focus-mode switch to the manual focus position **[MF]**.
2. While pressing the shutter release button lightly, turn the focusing ring either to the right or to the left to adjust the focus.
3. If the green in-focus signal [  ] comes on in the viewfinder, the focus is correct.
  - \* With the main switch set at the [  ] position, the correct focus is also confirmed by an electronic tone.

## USING EXPOSURE MEMORY LOCK FUNCTION

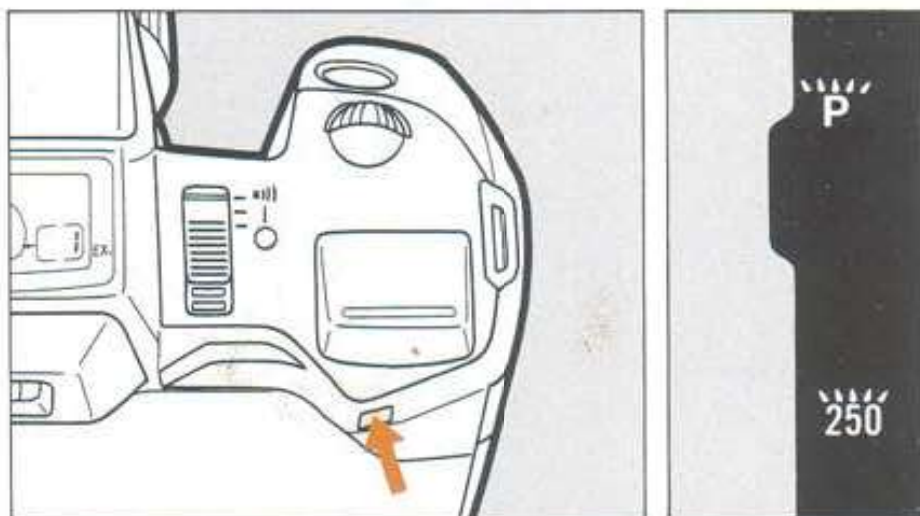

The exposure memory lock function temporarily memorizes the subject's exposure data to adjust the exposure in the automatic exposure mode. This function is especially useful for photographing people against a very contrasty background, such as backlighting or a bright sky.

1. Fill the viewfinder with the main element (subject's face, etc.) and press the memory lock [ML] button. As long as the ML button is pressed, the correct exposure is memorized for the subject's face. During memory lock, the exposure indications in the viewfinder blink rapidly.

Memory lock used



Not used



2. While maintaining the exposure data with the memory lock, compose the image and take the picture. The subject will be correctly exposed. When the shutter is released, the memory lock is cancelled.

- If you press the shutter release button lightly while the memory lock is activated, the memory is locked as long as the shutter button is depressed, even if you remove your finger from the ML button.

**Note:** When the [ML] button is pressed in the Metered Manual mode, a shutter speed indication in the viewfinder is fixed and blinks to indicate that the exposure is memorized.



## USING SELF-TIMER

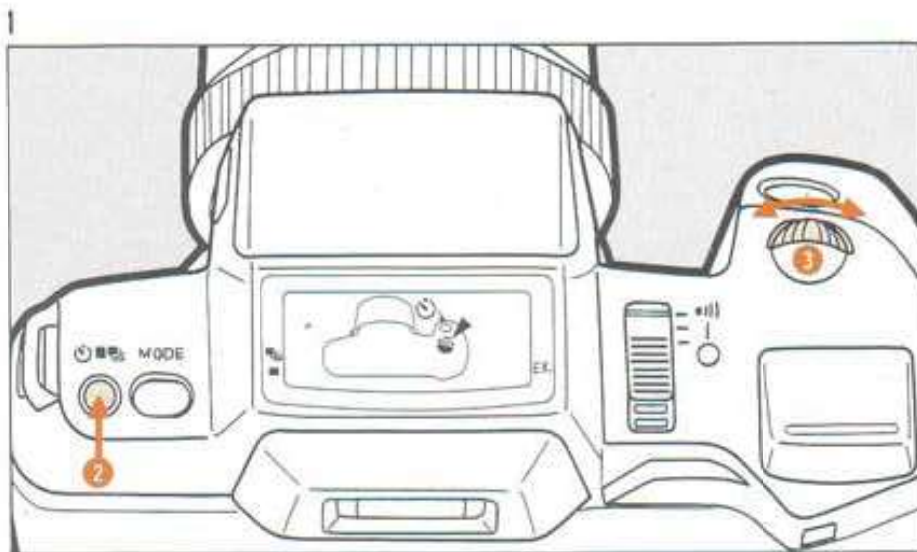



The self-timer delays shutter release and is useful in taking commemorative pictures that include the photographer.

1. Turn the select dial ① while depressing the drive button ② until the self-timer mark [  ] appears in the LCD panel.
2. While focusing on the subject, press the shutter release button all the way down, and the shutter will be released after approximately 12 seconds.

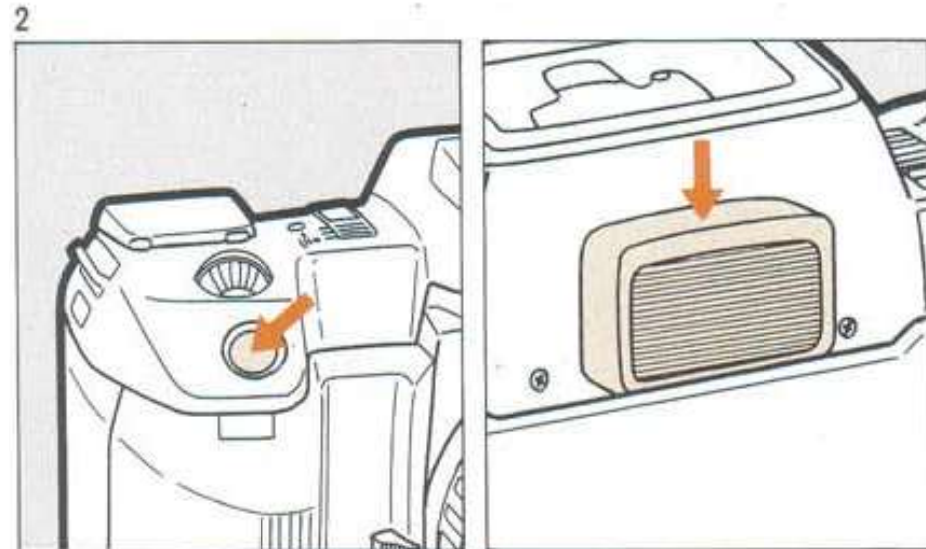
\* If the main switch is set at the [  ] position, the self-timer operation is confirmed by a self-timer lamp and an electronic tone. During the last two seconds before shutter release, the lamp blinks and the electronic tone beeps faster.



\* If you wish to interrupt the self-timer operation after it is activated, turn the main switch off. Also, if you turn the main switch on, the self-timer operation is canceled, and the drive mode is switched for single film-advance photography. (It can also be canceled by switching the drive mode to [  ] or [  ].)

When shooting in the AE mode with your eye away from the viewfinder eyepiece, such as in self-timer photography, light entering the eyepiece can cause incorrect exposure reading, resulting in underexposure. Therefore, use the viewfinder cap when taking a self-timer photograph.

## OTHER FUNCTIONS

Focusing in matte area .....	47
Using Pentax dedicated flash units .....	48
TTL Auto Flash and Programmed Auto Flash modes ..	50
Using Bulb mode .....	52
Infrared index .....	53
Eyecup FB .....	53
Viewfinder warnings .....	54
Depth of field .....	56
Functions using conventional Pentax lenses .....	58
● Precautions on battery .....	59
● Taking care of your camera .....	60
● Specifications .....	62
● Warranty policy .....	64

## FOCUSING IN MATTE AREA

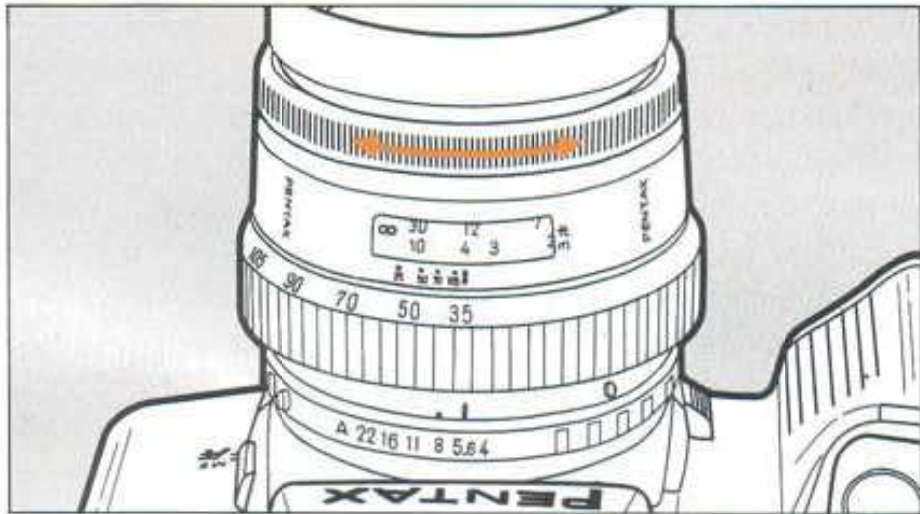

In the following situations, you cannot use the F.I. system, so it is necessary to focus manually using the matte area of the focusing screen.

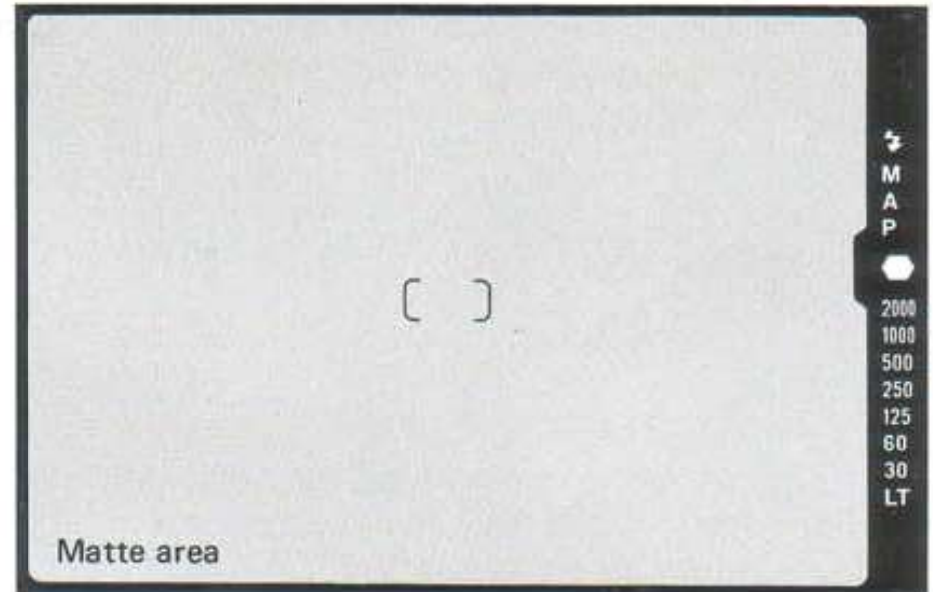



1. Subjects which the auto-focus system cannot measure accurately or for which the camera does not display the in-focus signal [  ].
2. Lenses with a maximum aperture smaller than f/5.6.
3. SMC PENTAX BELLOWS 100mm f/4, SMC PENTAX SHIFT 28mm f/3.5 and reflex-type lenses.
4. Screw-type Takumar lenses used with Mount Adapter K (optional).

## USING PENTAX DEDICATED FLASH UNITS

If the camera is set in an AE (automatic exposure) mode or the Metered Manual mode, a Pentax dedicated auto flash unit can be used anytime.

### How to Use an Accessory Flash

1. Remove the camera's hot-shoe cover and attach the flash unit.
2. Set the flash mode to TTL Auto or Programmed Auto.
3. Turn the flash's main switch on.
  - The completion of the flash-charging operation can be confirmed by checking the flash unit's flash-ready indicator, as well as the flash-ready indicator [  ] in the viewfinder which is turned on when the shutter release button is pressed halfway down. (The indications for the RTF are slightly different.)
  - As you remove your finger from the shutter-release button the [  ] mark and the glowing of a shutter speed disappear about five seconds later.
  - For this camera, please take advantage of the AF400FTZ or AF240FT flash, which possesses the many capabilities shown at right.



### Functions of RTF and Dedicated Auto Flash Units

- When using an old-type flash unit (AF160S or AF200S), use the lens aperture ring to select the desired f-number.
- The flash unit may not discharge if the subject is too bright to require a flash.
- \* The [  ] mark appears in the LCD panel when the flash is fully charged.
- ☆ AF200SA, AF240Z and AF160SA apply.

### TTL Auto Flash System

When you attach a Pentax dedicated TTL auto flash unit, the camera's metering circuits automatically control the flash output for a proper exposure by measuring the incoming light reflected off the film plane. Since this system measures only the light reflected by the subject, it ensures accurate exposure control.

## Functions of RTF and Dedicated Auto Flash Units

Camera's Functions	RTF	AF400FTZ AF240FT	AF400T AF280T AF200T AF080C	AF200SA AF240Z AF160SA AF200S AF160S
When flash charging is completed and the shutter release button is depressed halfway down, the flash-ready indicator [  ] appears in the viewfinder, and the shutter speed is automatically switched to the flash-sync speed.	○*	○	○	○
With the lens aperture ring locked at the "A" position, the appropriate aperture value is set automatically.	○	○	○	☆
Successful flash discharge is confirmed by the flash-ready indicator [  ] in the viewfinder, which either turns off briefly and back on again or blinks after exposure.		○	○	
Flash output is automatically controlled by measuring the amount of light striking the film plane during exposure. (TTL Auto Flash)	○	○	○	
Slow shutter-speed sync operation under 1/100 second is possible in the Metered Manual mode.	○	○	○	○
Built-in AF spotbeam projector for assisting auto focusing in dark locations.	○	○		
Selection of the leading shutter-curtain or trailing shutter-curtain sync mode.		○		

## TTL Auto Flash Mode

### For Programmed AE and Shutter-Priority AE Modes

- Like the built-in RTF unit, the AF400FTZ or AF240FT, which is designed exclusively for use with this camera, automatically adjusts the shutter speed and aperture according to the subject's brightness, making it easy to accomplish even complicated daylight flash synchronization. (See the operating manual of the flash for more detailed information).

- With a conventional dedicated flash unit (AF400T, AF280T, AF200T and AF080C), a flash-sync speed of 1/100 second and an aperture of f/4 (f/8 for AF080C) are set as soon as the flash is fully charged (at ISO 100). However, these units are not recommended for daylight flash sync photography.

\* The aperture is automatically set to f/4 with ISO 100 film. With the zoom lens whose maximum aperture changes from f/4 to f/5.6, for instance, according to the focal length in use, note that shooting at f/5.6 causes underexposure.

### For Aperture-Priority AE and Metered Manual modes

- Select the desired f-number using the lens aperture ring.
- The flash-sync speed of 1/100 second is set as soon as the flash is fully charged.

## Programmed Auto Flash Mode

### For Programmed AE and Shutter-Priority AE Modes

- Set the flash's mode switch at one of the AUTO (red, green or yellow) positions for dedicated flash units such as the AF400T, AF280T, AF200T and AF200SA.
- A combination of a flash-sync speed of 1/100 second and a lens aperture is selected as soon as the flash is fully charged, as indicated in the chart below.

(at ISO 100)

	AF400T	AF280T	AF200T
Red	f/4	f/4	f/2.8
Green	f/8	f/8	f/5.6
Yellow	f/11	—	—

(AF200SA: f/4 at ISO 100)

### For Aperture-Priority AE and Metered Manual Modes

- Set the flash's mode switch at one of the AUTO (red, green or yellow) positions.
- Set the same f-number on the lens as the one indicated by the flash's exposure scale.
- The flash-sync speed of 1/100 second is set as soon as the flash is fully charged.

### Common Functions of TTL Auto Flash and Programmed Auto Flash Modes

In the Metered Manual mode, slow-shutter-speed synchronization can be used by selecting a shutter speed between 1/60 second and one second. The shutter speed can be selected by turning the select dial to the left or right until the desired speed appears on the LCD panel.

- When the shutter speed is set between 1/2000 second and 1/125 second, it is switched to the flash-sync speed of 1/100 second when the flash is fully charged.

### Flash Confirmation Signal ( )

When a proper flash exposure is made in the TTL Auto Flash or Programmed Auto Flash mode while the camera is set in an AE or Metered Manual mode, the flash-ready indicator [  ] in the viewfinder confirms it right after the discharge, either by disappearing for a moment and coming back on again or by blinking.

\* The AF200SA does not have the flash confirmation signal function.



### Precautions for Using Pentax Dedicated Flash Units

- When using a flash unit in the manual sync (MS) or manual (M) mode, select an f-number using the lens aperture ring. If the ring is set at the "A" position, a correct exposure cannot be made. The functions in the MS and M modes may vary depending on the type of flash used, so check the operating manual of the flash in use for details.
- Multi-flash photography in the TTL Auto Flash or Programmed Auto Flash mode can be done by combining the RTF with the Pentax dedicated flash. In this case, the dedicated flash attached to the camera's hot shoe has a priority for different functions over the RTF. When combining conventional dedicated flash units, use the lens aperture ring to select the aperture. Be sure to check the flash-ready indicator of the attached flash unit before shooting.
- The TTL Auto Flash or Programmed Auto Flash mode can be used even when the camera is set in the **[bulb]** mode.
- When mounting the AF080C ring flash on the camera's hot shoe, use the Hot-shoe Adapter F which makes it easier to operate the shutter-release button.

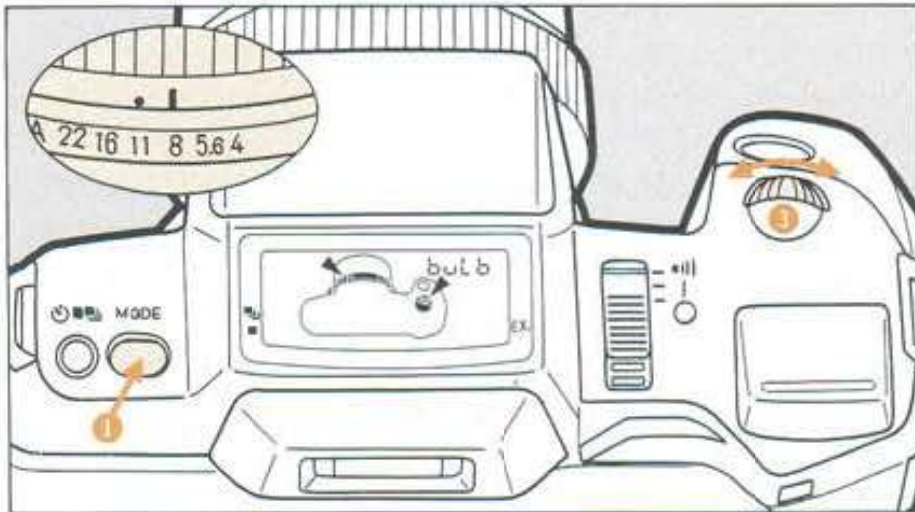
## USING BULB MODE



This mode is useful in long exposures for photographing fireworks and night scenes. The shutter remains open as long as the shutter release button is held down.

1. Turn the select dial  while pressing down the mode button  until the **[bulb]** indication appears in the LCD panel.
  - When the shutter release button is pressed lightly, the **[M]** indication comes on in the viewfinder. (Set the aperture ring at an f-number other than **[A]**.)

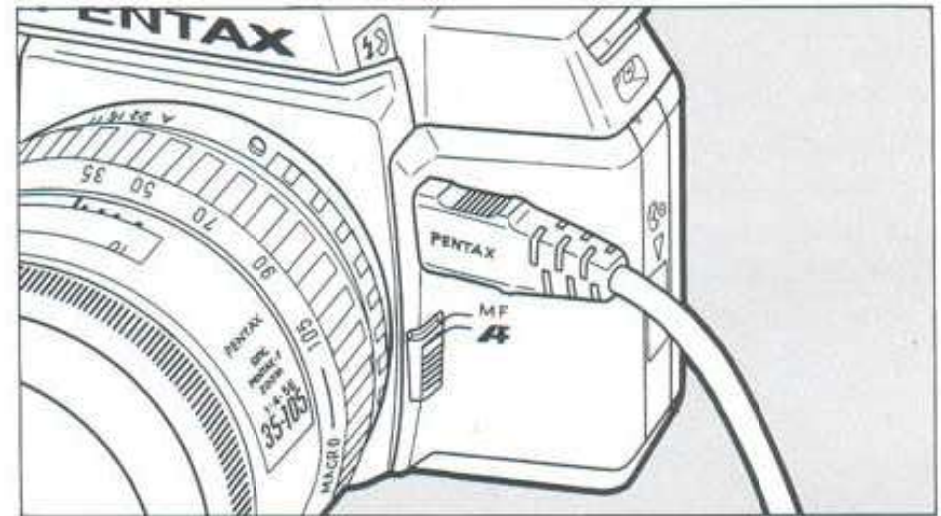

2. When photographing in the bulb mode, use a strong tripod and connect the optional Cable Switch F to the camera's Release socket F.

### Note:

- The self-timer cannot be used in the bulb mode.
- With a fresh lithium battery at a normal temperature, an exposure of up to ten hours is possible.

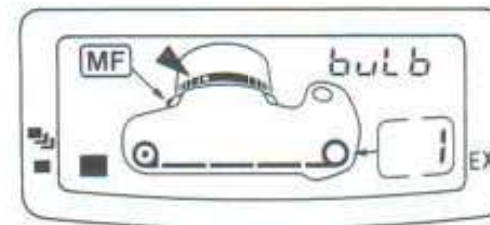

The  indication appears, telling you to select an aperture.



## INFRARED INDEX

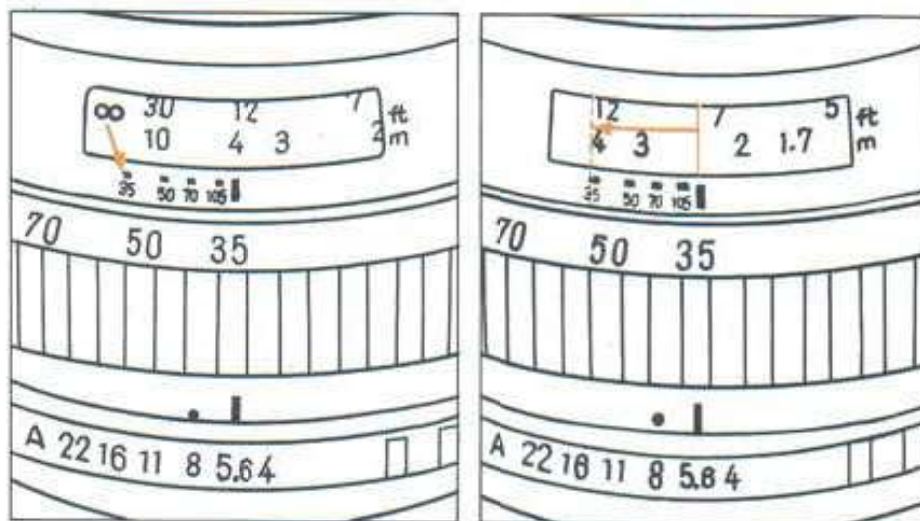

In infrared photography when using infrared film and an R2 or O2 filter, you need to adjust the focusing to compensate for infrared rays, which are different from the visible rays of normal photography.

Memorize the subject's distance indicated on the lens distance scale after focusing, then turn the focusing ring to align that distance setting with the red infrared index before shooting. As shown above, for instance, when the zoom ring is at 35, move the distance figure to the infrared index of 35.

- Be sure to set the focus-mode switch at the [MF] position before turning the focusing ring manually.

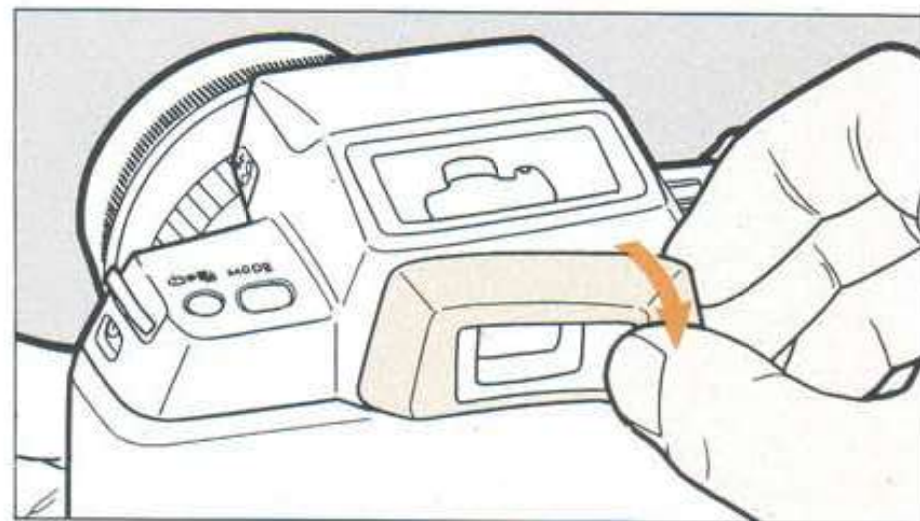

## EYECUP FB



The Eyecup FB is attached to the viewfinder accessory groove.

When using such accessories as "Diopter Correction Lenses M," "Viewfinder Cap M," etc., remove the Eyecup FB from the camera.

## VIEWFINDER WARNINGS

Viewfinder	Remarks
P 2000	The subject is out of the metering range of the Programmed AE mode. The correct exposure cannot be obtained using the current settings. (The normal-speed blinking of "LT" warns you of camera shake, while the faster-speed blinking indicates an out-of-metering range.)
P LT	
A 2000	The subject is out of the shutter-speed/aperture coupling range or the metering range in the Shutter-Priority AE mode. The correct exposure cannot be obtained using the current settings. In the former case, change the shutter speed to obtain the correct exposure. In the latter case, the indicators will keep blinking even if the shutter speed is changed.
A LT	
A 2000	The subject is out of the shutter-speed/aperture coupling range or the metering range in the Aperture-Priority AE mode. The correct exposure cannot be obtained using the current settings. In the former case, change the aperture to obtain the correct exposure. In the latter case, the indicators will keep blinking even if the aperture is changed. (The normal-speed blinking of "LT" warns you of camera shake, while the faster-speed blinking indicates an out-of-metering range.)
A LT	
M 500 125	The subject is out of the Metered Manual mode's correct exposure range. Change the shutter speed and/or the aperture until only one solidly lit indicator remains; this indicates correct exposure is possible.
M 250 60	
M 2000	The subject is out of the Metered Manual mode's metering range. The indicators will keep blinking even if the shutter speed and/or the aperture are changed. The correct exposure cannot be obtained using the current settings.
M LT	
P 250	When the exposure memory lock is in use, the viewfinder indicators blink to confirm it.
P 60	The low battery level is warned by blinking indications. The battery mark [  ] also blinks in the LCD panel.
	When the subject requires the use of flash, the [  ] mark blinks and tells you to use flash.

### Out-of-meter-coupling-range warning

- The warning is indicated by a blinking light.
- “Out-of-metering-range” means the subject is beyond the measurable limits of the camera’s exposure meter because of extremely bright or dark lighting conditions.
- “Out-of-coupling-range” means a combination of shutter speed and aperture is not available even if the lighting condition is within the metering range.
- The [⚡] mark in the chart at left indicates blinking.

### How to photograph an out-of-metering-range subject:

1. If the subject is too bright, use an ND (neutral density) filter (available at camera shops).
2. If the subject is too dark, use a flash or other lighting equipment.

# DEPTH OF FIELD

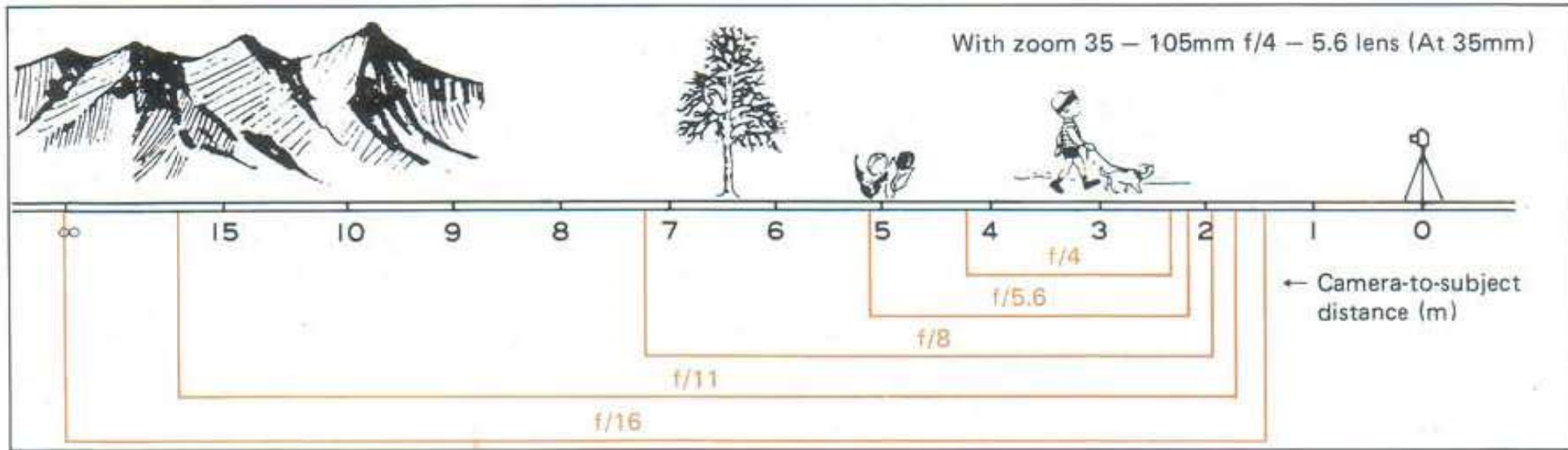

Depth of field refers to the range around the optimum focusing point of the subject in which the elements at different distances are in focus.

The depth of field increases as the aperture becomes smaller, as the focal length of the lens becomes shorter, and as the subject is positioned farther away. By changing apertures, you can control the depth of field and create different visual effects.

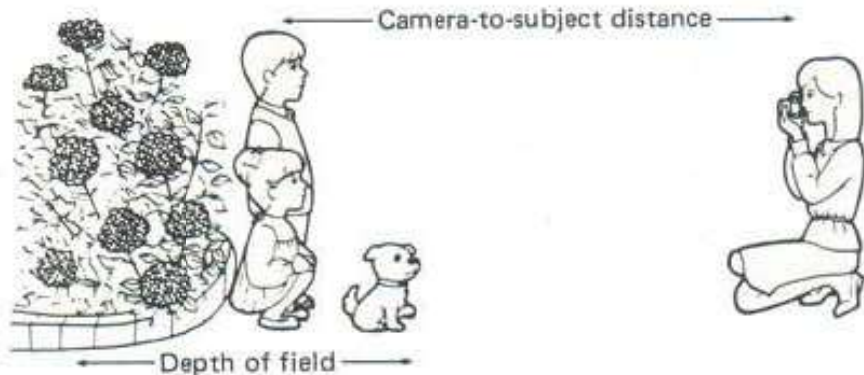

\* Some zoom lenses do not have a depth-of-field scale due to mechanical reasons.

Aperture set at maximum



Aperture set at minimum



## FUNCTIONS USING CONVENTIONAL PENTAX LENSES

Camera's Functions	Exposure Mode		Focusing Mode			
	Programmed AE Shutter- Priority AE	Aperture- Priority AE Metered Manual	Auto Focus		Manual Focus	
				With AF Adapter 1.7X	FI System	Matte Screen Focusing
<b>SMC Pentax Lenses</b>						
F-series lenses	○	○	○	—	○	○
A-series lenses	○	○	x	○*	○*	○
M-series lenses	x	○	x	○*	○*	○
Pentax lenses	x	○	x	○*	○*	○
Takumar lenses	x	○*	x	x	x	○

\* Note: Conventional Pentax lenses have the following restrictions:

- The Focus Indication (F.I.) system of the manual focusing mode [MF] can only be used for lenses with the maximum aperture of f/5.6 or larger.
- The auto-focus system using the SMC PENTAX-F AF Adapter 1.7X can only be used for lenses with the maximum aperture of f/2.8 or larger. (For details, please read the operation manual of the SMC PENTAX-F AF Adaptor 1.7X.)

\* The metering system is switched to stop-down metering.

• Manual focusing can be done using the peripheral matte area of a focusing screen without being affected by the auto-focus frame [⊞].

With screw-mount Takumar lenses, the in-focus signal [⊞] is not displayed.

## PRECAUTIONS ON BATTERY

- This camera is powered by one "2CR5"-type lithium battery.
- Inserting or handling the battery improperly may result in leakage, heat generation or explosion. Be sure to insert the battery with its (+) or (-) side facing correctly as indicated in the chamber.
- When not using the camera for an extended period of time, remove the battery from the camera and keep it somewhere beyond reach of small children. An old battery is apt to leak and can cause damage to the battery chamber.
- Never try to break up, or recharge the battery, or throw old ones into fire; they may explode.
- The battery may not function properly in low temperatures, although it depends on the type and brand.

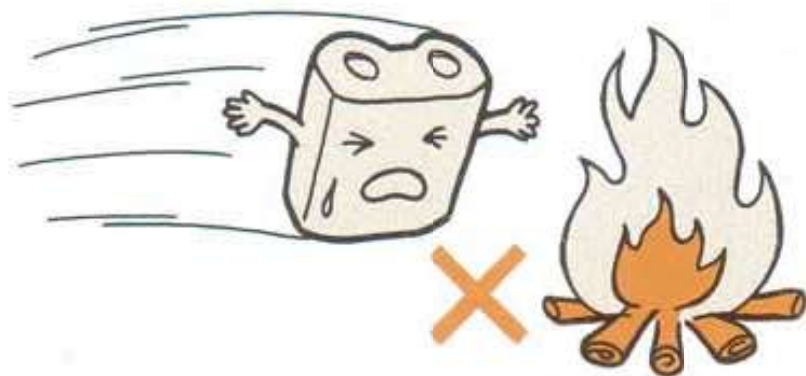

- Just to be safe, carry a spare battery when shooting outdoors or on a trip.
- When storing the camera in a bag or a case, make sure the main switch is turned off, to avoid accidental shutter release and unnecessary battery consumption.
- When the built-in flash (RTF) is used continuously, the battery may heat slightly, but it does not mean the battery is faulty; it is one of the battery's characteristics.

- **Battery life** (according to number of rolls of film used and use of bulb mode):

<b>Normal temperature</b>	Without RTF	Approx. 150 rolls
	With RTF (used for 50% of exposures)	Approx. 40 rolls
	With RTF (used for every exposure)	Approx. 20 rolls
<b>Bulb exposure time</b> (at normal temperature)		Approx. 10 hours

- Under Pentax testing conditions
- The number of rolls is based on use of 24 exposure film.

## TAKING CARE OF YOUR CAMERA

Your Pentax camera is a sophisticated, precision instrument built to give long-lasting, reliable service. It will serve you well if you treat it right, with proper handling and reasonable care. The major cause of damage are:

1. Dropping or banging the camera against immovable objects, which can damage the camera in many ways.
2. Water damage, particularly if the camera is submerged in salt water. Your camera is not water-proof! It must be protected from salt breeze, salt spray at the beach, splashing of any kind, and shielded from the rain. If your camera does get soaked, wipe it dry immediately and rush it to a Pentax service center.

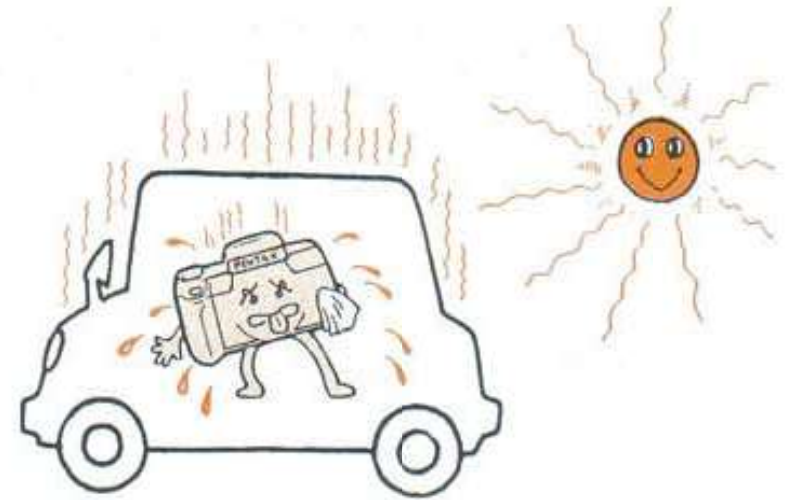

3. Dirt and sand can cause serious damage to the shutter and other moving parts of the camera. Your camera needs periodic cleaning to keep it operating properly. To remove dirt and dust, you need lens-cleaning fluid, lens-cleaning tissues, bulb-type ear syringe, camel's hair-brush, etc. Never use a solvent such as thinner or alcohol.
4. Humidity and temperature extremes should be avoided. Keep your camera out of direct sunlight, car trunks, and glove compartments. Shooting outdoors in winter presents a problem since batteries won't function if they get too cold. In cold weather carry your camera under your coat or jacket to keep the batteries warm. The temperatures at which this camera should function properly are approx. 50° ~



-10°C. Sudden changes in temperature will often cause moisture to condense inside or outside your camera. This is a possible source of rust, which may be extremely harmful to the mechanism.

Furthermore, if the camera is taken from a warm temperature to a sub-freezing one, further damage may result from the formation of icelets. Thus, sudden temperature changes should be avoided as much as possible. As a guide, a temperature change of 10°C should be allowed to take place gradually over a period of at least 30 minutes. If this is not possible, keeping the camera in its case or bag will help somewhat in minimizing the effects of a rapid temperature change.

5. Vibration experienced when you are traveling in a car, plane, or ship, can cause screws to loosen. To minimize this problem use foam-rubber padding about one inch thick to line the bottom of your camera bag.
6. When mounting your camera on a tripod, make sure the tripod screw is no longer than 5.5mm, which is the depth of your camera's tripod socket. If you use a longer screw, you will possibly puncture the tripod socket, after which the camera will not function properly.

### Precautions on LCD Display

- In temperatures over approximately 60°C, the LCD display may darken. It will return to its normal condition under normal temperatures.
- In low temperatures, the LCD display may respond more slowly. This is due to the characteristics of the liquid used and is not a malfunction.

### Backup Circuits for LCD Display

Even when the battery is removed for replacement during shooting, the built-in backup circuits retains data such as the frame number and the ISO film speed in memory until a new battery is inserted.

### Special notes on accessories

- When the Auto Bellows A is combined with this camera, the Double Release A cannot be used. When shooting with the camera held vertically, keep the camera's grip on the upper side.
- When using the "Adapter K for 645 Lens" with this camera, note that the fixing screw may hit the camera, depending on where the adapter is fitted.
- The Magnifier F, Eyecup F, and Hotshoe Cover F, which are the accessories for the SFX/SF1, cannot be used with your camera. Use the Magnifier M.

## SPECIFICATIONS

<b>Type:</b>	TTL auto-focus, multi-exposure-mode, fully automatic 35mm SLR with built-in RTF (Retractable TTL Auto Flash).
<b>Film:</b>	35mm perforated cartridge film.
<b>Format:</b>	25mm x 36mm.
<b>Lens:</b>	SMC Pentax-F. (K-and KA-mount lenses with maximum aperture of f/5.6 or larger usable in Focus Indication system.)
<b>Lens Mount:</b>	Pentax KAF-mount with auto-focus coupler and lens/focus information contacts. (Compatible with K and KA mounts.)
<b>Focusing System:</b>	Pentax TTL phase-matching auto-focus system. Usable illumination range: EV 2 to EV 18 (at ISO 100). Focusing modes: (1) AF Single (with focus-lock device) and (2) Manual. Focusing response: approx. 0.3 sec. (from infinity to minimum focusing distance using SMC Pentax-F 35mm-70mm f/3.5-f/4.5 lens). AF assisting system: AF spotbeam projector of RTF for automatic beam casting under low-light conditions with effective range of 1m to 4m.
<b>Exposure Control:</b>	Light metering: TTL center-weighted PROCES (Progressive Contrast-compensation Exposure System) with automatic exposure compensation depending on brightness difference between two divided sections in viewfinder field. Metering range: EV 1 to EV 19 (ISO 100 with f/1.4 lens). Exposure modes: (1) Programmed AE; (2) Shutter-Priority AE; (3) Aperture-Priority AE; (4) Metered Manual; (5) Bulb; (6) TTL Auto Flash; and (7) Programmed Auto Flash. Exposure compensation: automatic compensation by contrast variation or via exposure-memory-lock button.
<b>Shutter:</b>	Electronically controlled vertical-run focal-plane shutter. Shutter speeds: (1) auto: 1/2000 sec. to 30 sec.; (2) manual: 1/2000 sec. to 1 sec.; (3) bulb.
<b>Viewfinder:</b>	Pentaprism finder. Field of view: 92%. Magnification: 0.82X (with 50mm f/1.4 lens at infinity, -1 diopter eyepiece. Aspheric-Micro-Matte focusing screen. LED indications: In-focus, Programmed AE, Aperture-Priority AE, Shutter-Priority AE, Metered Manual, shutter speed, low-light warning/flash readiness, flash-exposure confirmation with dedicated flash unit and memory-lock warning.

<b>External LCD Information:</b>	Focus mode, exposure mode, shutter speed, RTF recommendation (low-light warning), recharge completion, successful discharge, illumination-angle warning, exposure counter, film winder mode, film loading/winding/rewinding, film loading error, self-timer, low battery warning and aperture-ring/select dial instructions.
<b>Mirror:</b>	Swing-up-type instant-return mirror with AF secondary mirror.
<b>Built-in Flash:</b>	RTF (Retractable TTL Auto Flash) with AF spotbeam projector. Guide number: 12 (at ISO 100/m). Illumination angle: coverage for angle of view of lenses with focal length of 35mm or longer. Recycling time: approx. 4 sec. with fresh lithium battery.
<b>Flash Synchronization:</b>	With built-in RTF or via accessory hotshoe. Sync speed: 1/100 sec. set automatically with RTF or dedicated auto flash upon full charge. Automatic flash-exposure adjustment by built-in RTF, AF400FTZ and AF240FT according to lighting conditions (1/60 sec. to 1/100 sec. and f/2.8 to f/11 at ISO 100 with automatic determination of discharge). TTL Auto Flash mode possible with Pentax dedicated flash units (AF400FTZ, AF240FT, AF400T, AF280T, AF200T and AF080C).
<b>Film Advance/Rewind:</b>	Automatic winding/rewinding and automatic rewind stop by built-in film winder. Advance modes: (1) single frame and (2) consecutive (at approx. 2 frames/sec.).
<b>Film Speed Setting:</b>	Automatic with DX-coded film from ISO 25 to 5000. (Fixed setting at ISO 100 with non-DX-coded film.)
<b>Self-timer:</b>	Electronically controlled type with delay time of approx. 12 sec. Operation confirmation by LED indicator, PCV beep tone and LCD panel.
<b>Power Source:</b>	One 6V lithium battery (2CR5). Battery life: approx. 100 rolls of 24 exposure film without flash; approx. 30 rolls of 24-exposure film with flash used for 50% of shooting.
<b>Dimensions:</b>	152.5mm(W) x 96mm(H) x 63.5mm(D) (6.0" x 3.7" x 2.5")
<b>Weight:</b>	630 g (22.2 oz.).

**SPECIFICATIONS ARE SUBJECT TO CHANGE WITHOUT ANY OBLIGATION ON THE PART OF THE MANUFACTURER.**

## WARRANTY POLICY

All Pentax cameras purchased through authorized bona fide photographic distribution channels are guaranteed against defects of material or workmanship for a period of twelve months from date of purchase. Service will be rendered and defective parts will be replaced without cost to you within that period, provided the equipment does not show evidence of impact, sand or liquid damage, mishandling, tampering, battery or chemical corrosion, operation contrary to operating instructions, or modification by an unauthorized repair shop. Because the tolerances, quality, and design compatibility of lenses other than Pentax lenses are beyond our control, damage caused by use of such lenses will not be covered by this warranty policy. The manufacturer or its authorized representatives shall not be liable for any repair or alterations except those made with its written consent and shall not be liable for damages from delay or loss of use or from other indirect or consequential damages of any kind, whether caused by defective material or workmanship or otherwise; and it is expressly agreed that the liability of the manufacturer or its representatives under all guarantees or warranties, whether express or implied, is strictly limited to the replacement of parts as hereinbefore provided. No refunds will be made on repairs performed by non-authorized Pentax service facilities.

### Procedure During 12-month Warranty Period

Any Pentax which proves defective during the 12-month warranty period should be returned to the dealer from whom you purchased the equipment or to the manufacturer. If there is no representative of the manufacturer in your country, send the equipment to the manufacturer, with postage prepaid. In this case, it will take a considerable length of time before the equipment can be returned to you owing to the complicated customs procedures required in Japan in importing and re-exporting photographic equipment. If the equipment is covered by warranty, repairs will be made and parts replaced free of charge, and the equipment will be returned to you upon completion of servicing. If the equipment is not covered by warranty, regular charges of the manufacturer or of its representatives will apply. Shipping charges are to be borne by the owner. If your Pentax was purchased outside of the country where you wish to have serviced during the warranty period, regular handling and servicing fees may be charged by the manufacturer's representatives in that country. Notwithstanding this, your Pentax returned to the manufacturer will be serviced free of charge according to this procedure and warranty policy. In any case, however, shipping charges and customs clearance fees are to be borne by the sender. To prove the date of your purchase when required, please keep the receipts or bills covering the purchase of your equipment for at least a year.

Before sending your equipment for servicing, please make sure that you are sending it to the manufacturer's authorized representatives or their accredited repair shops, unless you are sending it directly to the manufacturer. Always obtain a quotation of the service charge, and only after you accept the quoted service charge, instruct the service station to proceed with the servicing.

This warranty policy does not apply to Pentax products purchased in the U.S.A., U.K., or Canada. The local warranty policies available from Pentax distributors in those countries supersede this warranty policy.

## NOMENCLATURE

- 30 Film chamber
- 31 Rewind shaft
- 32 Shutter curtain
- 33 Eyecup FB

- 34 Viewfinder eyepiece
- 35 Viewfinder-accessory groove
- 36 Memory-lock (ML) button
- 37 Film-information window
- 38 Pressure plate
- 39 Back cover

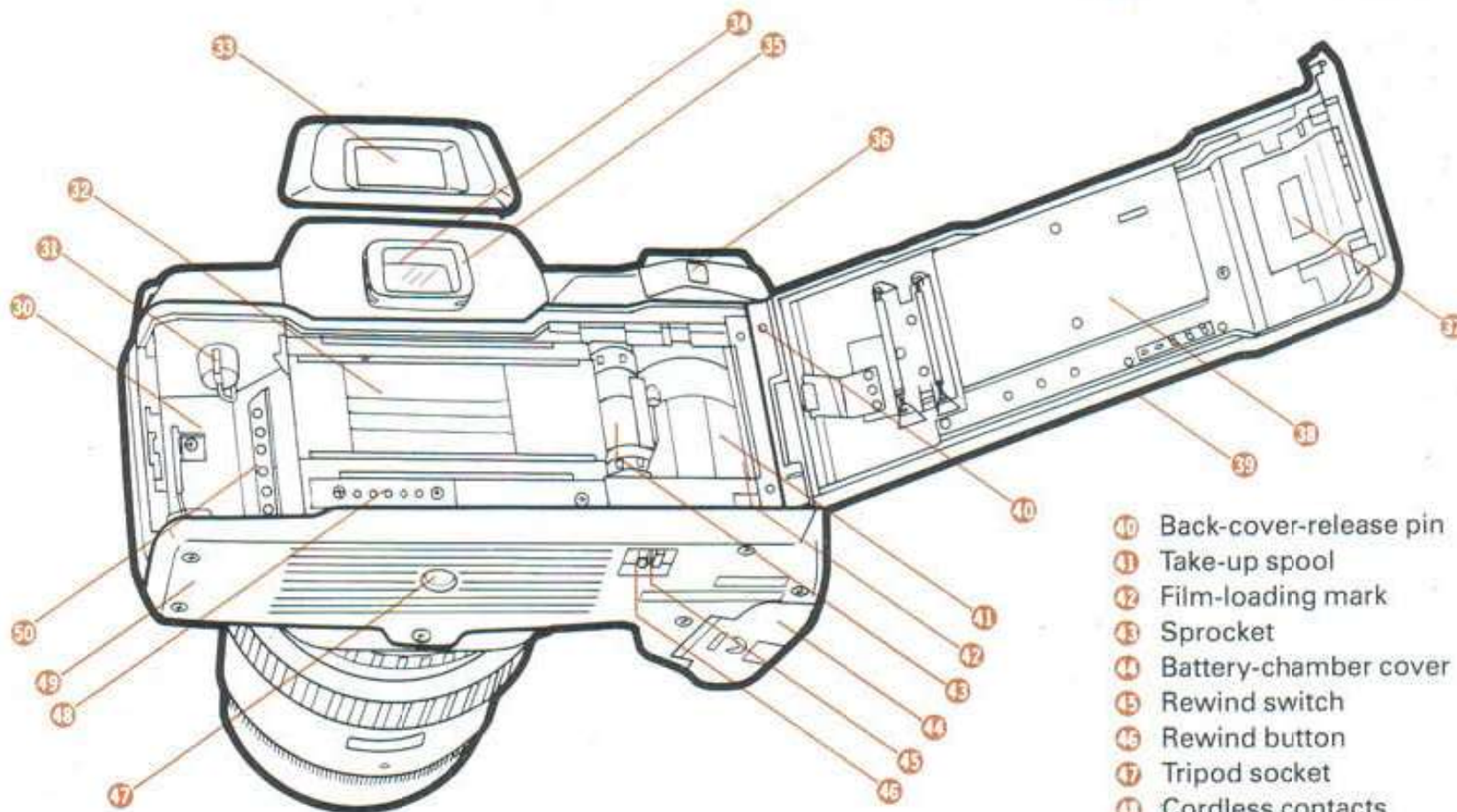

- 40 Back-cover-release pin
- 41 Take-up spool
- 42 Film-loading mark
- 43 Sprocket
- 44 Battery-chamber cover
- 45 Rewind switch
- 46 Rewind button
- 47 Tripod socket
- 48 Cordless contacts
- 49 Bottom cover
- 50 DX-information pins

## VIEWFINDER INDICATION

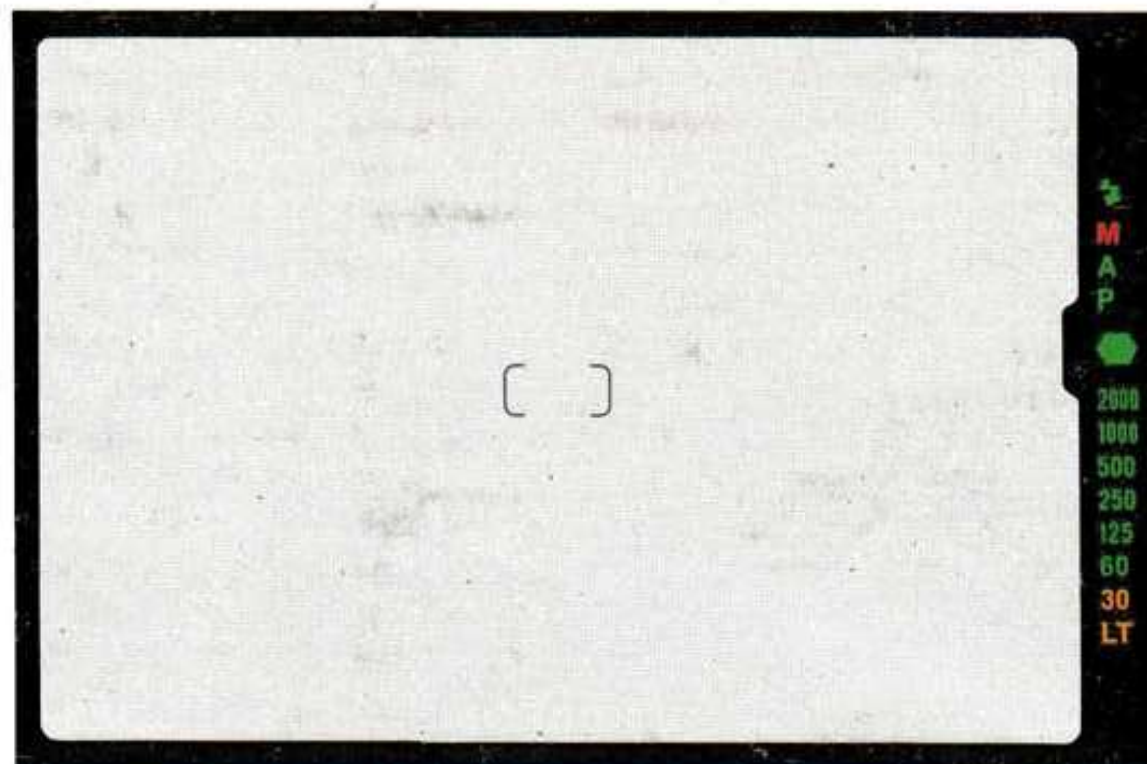

[ ]

Indicates the auto-focus frame where the subject should be positioned.

⚡

Indicates the condition of the RTF.

M

Indicates the Metered Manual mode is selected.

A

Indicates the Shutter-Priority AE or Aperture-Priority AE mode is selected.

P

Indicates the Programmed AE mode is selected.

⬡

Indicates the condition of focusing.

2000

1000

500

250

125

60

30

LT

Indicates a shutter speed. "2000" means 1/2000 second and "60" means 1/60 second.

Indicates a shutter speed prone to camera shake

Warns of a shutter speed slower than 1/15 sec.



**Asahi Optical Co., Ltd** C.P.O. 895, Tokyo 100-91, JAPAN  
**Pentax Europe n.v.** Weiveldlaan 3-5, 1930 Zaventem, BELGIUM  
**Pentax Handelsgesellschaft mbH.** Postfach 54 0169, 2000 Hamburg 54, WEST GERMANY  
**Pentax U.K. Limited** Pentax House, South Hill Avenue, South Harrow, Middlesex HA2 0LT, U.K.  
**Pentax France** Z.I. Argenteuil, 12, Rue Ambroise-Croizat, 95100 Argenteuil, FRANCE  
**Pentax Nederland** Spinveld 25, 4815 HR Breda, THE NETHERLANDS  
**Pentax (Schweiz) AG** Industriestrasse 2, 8305 Dietlikon ZH, SWITZERLAND  
**Pentax Scandinavia AB** Box 650, S-751 27 Uppsala, SWEDEN  
**Pentax Norge A.S.** Cecilie Thoresens Vei 11, Lambertseter, 1153 Oslo 11, NORWAY  
**Pentax Corporation** 35 Inverness Drive East, Englewood, Colorado 80112, U.S.A.  
**Pentax Canada Inc.** 3131 Universal Drive, Mississauga, Ontario L4X 2E5, CANADA  
**Asahi Optical Brasileira** R. Capitão Antonio Rosa 376, Sala 121 Ed. PBK, São Paulo, BRAZIL